

Uf 821 CO & RV

(open channel or river)

User manual



Ultraflux

9, Allée Rosa Luxemburg
95610 ÉRAGNY, FRANCE
Tél : 33 (0)1 30 27 27 30
Fax : 33 (0)1 30 39 84 34

2014 ULTRAFLUX S.A.

All rights reserved. No part of this document may be reproduced without prior written authorisation from ULTRAFLUX S.A. ULTRAFLUX, Uf 821 are registered trademarks of ULTRAFLUX S.A.

TABLE OF CONTENTS

Note: A detailed table of contents is provided at the end of the manual.

Important: If you are unfamiliar with the transit time difference measuring technique, we recommend you start by reading our training manual "Ultrasonic transit time flowmeter".

CHAPTER 1: OVERVIEW	4
1.1 General view of the converter	5
1.2 Nature of the equipment	7
1.3 Dimensions and weight	7
1.4 Operating environment	7
1.5 Physical protection	7
1.6 Power supply	8
1.7 Communication	8
1.8 Inputs/Outputs	9
1.9 Ultrasound chords	9
1.10 Navigation keys	9
1.11 Operating lights	10
1.12 Screen	10
1.13 Functions	11
1.14 Performance of the flow meter	11
1.15 Cleaning the flow meter	11
1.16 Recycling the flow meter	12
1.17 CE marking	12
CHAPTER 2: SAFETY INSTRUCTIONS	13
2.1 Using the flow meter	14
2.2 Equipment connected to the flow meter	15
2.3 Symbols used on the flow meter	15
2.4 Maintenance work on the flow meter	16
2.5 Contact address	17
CHAPTER 3: INSTALLATION AND WIRING	18
3.1 General	19
3.2 Wall mounting and space requirement	19
3.3 Using the cabinet	20
3.4 Using the lid stay	21
3.5 Tool-free removal of the lid	21
3.6 Wiring instructions	22
3.7 Connection to the protective ground (to be carried out first)	22
3.8 Wiring the Terminals	22
3.9 USB Connection	27

CHAPTER 4: IMPLEMENTING A MEASURING POINT	28
4.1 Choosing the measurement location	29
4.2 Installing the probes	29
4.3 Measurements to be taken on site	30
4.4 Analysing and processing data measured on site	30
4.5 Transferring the data collected to the converter	31
CHAPTER 5: USING AND CONFIGURING THE Uf 821	32
5.1 Using the Uf 821	33
5.2 Main configuration elements	36
5.3 Configuring the Uf 821	39
5.4 SIMPLE configuration mode	40
5.5 NORMAL configuration mode	58
5.6 ADVANCED configuration	61
5.7 "Measurement" mode	64
CHAPTER 6: FUNCTION ENGINE	67
6.1 Principle	68
6.2 Application example	68
CHAPTER 7: PC SOFTWARE	69
7.1 Introduction	70
7.2 Archiving, processing and printing of saved files	84
7.3 Settings files	84
Appendix I: Characteristic echo signals	85
Appendix II: Speed of sound in water	88
Appendix III Troubleshooting	90
III.1 Diagnostic indications	91
III.2 Description of fault bits	93
III.3 Fault grid	96
Appendix IV: Link protocol of the Uf 821	97
IV.1 Serial link characteristics	98
IV.2 Reading of N words (with $N \leq 125$)	99
IV.3 Modbus / Jbus table	100
IV.4 CRC16 calculation algorithm	104

CHAPTER 1: OVERVIEW

1.1 General view of the converter

1.1.1 Unit closed

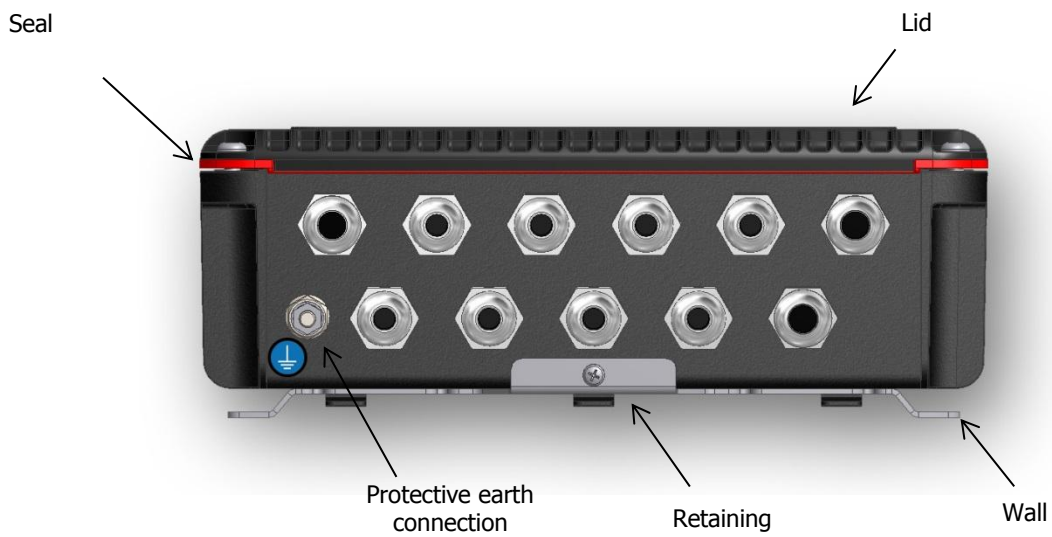
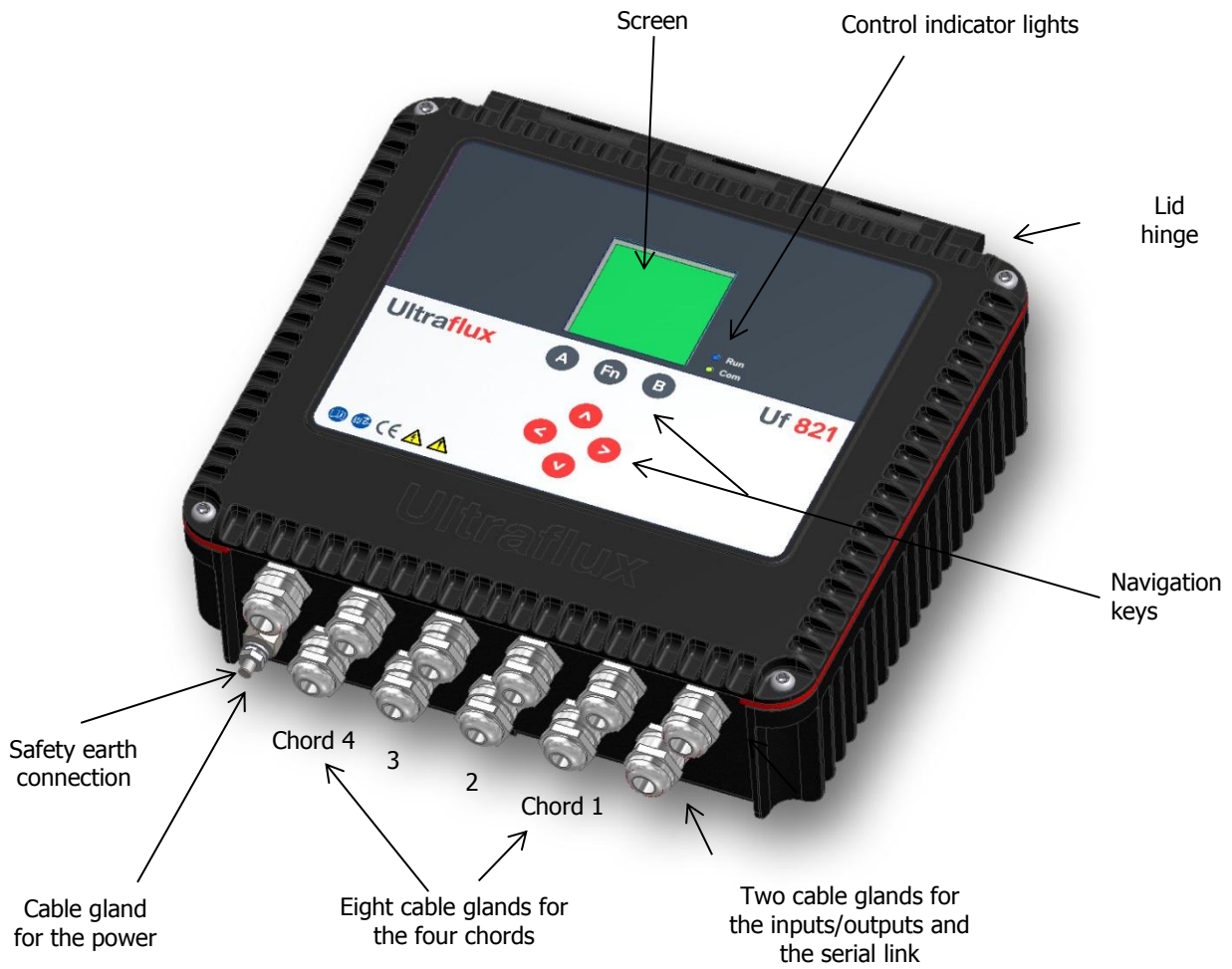

1.1.2 Unit open

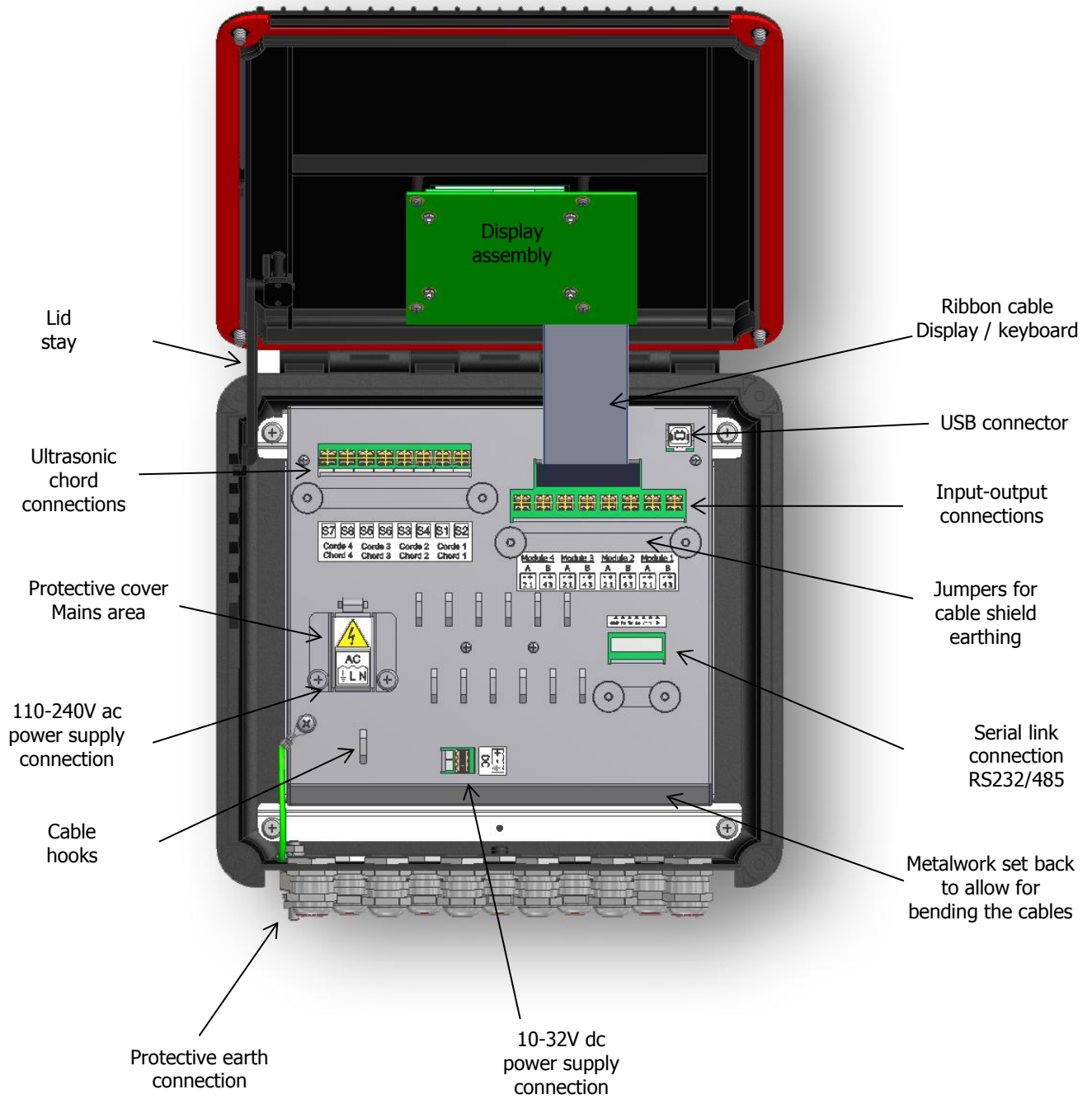

1.2 Nature of the equipment

The Uf 821 is an ultrasonic flow meter used to measure free surface flows using the transit time difference method.

The measurement can be taken using an installation with up to 4 ultrasonic measurement chords. (One chord designates the acoustic path between two probes, each alternating between emitting and receiving. The use of several chords is above all required when the hydraulic conditions are poor and high accuracy is required).

1.3 Dimensions and weight

- Height: 100 mm
- Width: 290 mm
- Depth: 290 mm (with cable glands)
- Weight: 3 kg (without wall mounting plate)

1.4 Operating environment

- For internal or external use
- Temperature: -20°C to +60°C
- Ventilation: no specific precautions
- Maximum altitude: 2,000 metres
- Hygrometry: 80 % maximum
- Weight: 3 kg (without wall mounting plate)

1.5 Physical protection

IP 67: Total protection against dust; protection against immersion for 30 minutes under 1m of water. This protection is only valid if installation is done or audited by Ultraflux.

Sealing is only effective when the glands and/or grommets are in place and secured (tightening torque checked).

Tightening torque for glands:

PG11 (cable diameters: 5 to 10 mm): 6 Nm

PG13.5 (cable diameters: 6 to 12 mm): 8 Nm

1.6 Power supply

- Range: from 10 to 32 VDC, or from 110 to 240 VAC 50-60Hz
- Peak power consumption: < 15 W
- Transient overvoltage: overvoltage category II
- Overvoltage protection in accordance with standard EN 61000-4-5
- Typical average consumption: < 6 W
- Protection against polarity reversal
- Protection through resettable fuse

Important safety-related notes:

- A bipolar isolating switch with visible 2 A cut-off upstream of the device's power supply must be installed. It is also recommended to install lightning arrestors on each of the unit's inputs/outputs (requires specialist advice).
- Whatever the means of power supply to the unit, it is recommended to install an isolating mechanism close to it (emergency stop or other).
- The flow meter is designed for fixed installation and must not be connected to the mains with a plug-in cable (risk of an unidentified or poorly identified phase on a mains socket). It must be connected to a terminal board on which the phase is correctly identified.
- Crimp wiring lugs must be fitted on the exposed ends of the cable used to connect the mains to the terminal board provided for this purpose (Ground + phase + neutral).
- The terminal boards must only be connected or disconnected with the power off and the equipment isolated.
- During maintenance or installation operations, the protective ground (external ground connection on the box) must be connected first and disconnected last.

Ultraflux accepts no responsibility for incidents which may occur following a failure to respect these instructions.

1.7 Communication

The Uf 821 has a serial link which can be wired using **RS232** or **RS485** mode, as well as a **USB port**. For this communication interface, the standard protocol chosen is the Slave JBUS (MODBUS). This enables the unit to be connected to an instrumentation and control system or to a computer. Ultraflux provides PC software compatible with Windows (XP or later) which is used to configure the machine, unload the logger data and display the various values measured.

Please refer to the appendices for the JBUS/MODBUS configuration.

Note:

- The 120 Ohm "termination" resistance is provided in the electronic card to connect the RS485 A/+ and B/- signals. To connect it, a jumper (strap) should be fitted to the serial link terminal board as indicated on the label describing the connection.
- A USB interface allows a computer to be connected for configuration. This may be accessed by opening the flow meter cover.

1.8 Inputs/Outputs

The Uf 821 provides the following options:

- Up to 4 input/output single modules (or 2 double modules), made by Ultraflux in the factory only (in accordance with the customer order).
- Insulation of all the inputs and outputs. There is therefore no requirement for additional insulation for the external equipment connected to them.

The Uf 821 allows 6 types of inputs/outputs to be used (maximum values in brackets):

- Single module 1 active 4-20 mA insulated analogue output: current from 0 to 24 mA (24 V maximum),
- Single module 2 passive 4-20 mA insulated analogue inputs: 0 to 24 mA (50 mA maximum),
- Single module 2 passive 0-10 V insulated analogue inputs (15 V maximum),
- Single module 2 on/off outputs that can be used as frequency outputs (50 V - 10 mA maximum),
- Single module 2 on/off inputs (5 V maximum),
- Double module 2 PT100/PT1000 temperature inputs; 2-, 3- or 4-wire.

Notes:

- Please refer to the descriptive sheet for each module for more details.
- The probes (inputs) on the 4-20 mA loop must be powered from an external power supply.

1.9 Ultrasound chords

The Uf 821 enables the control of a maximum of 4 ultrasonic chords, or 8 probes. 8 cable glands are provided to pass the probe cables through.

In principle, only ultrasonic probes supplied by Ultraflux may be used with the Uf 821. Ultraflux accepts no responsibility for damage or incidents which may occur following a failure to respect these instructions. It is however possible to use other makes of probe after consulting Ultraflux.

1.10 Navigation keys

- The "Fn" (Function) key is used to go from one menu to another. This is used in particular to enter the different "configuration" menus. The ◀ and ▶ keys are used to browse through the menus of this mode.
- Holding down the Fn key, or allowing approximately 1 minute to pass without using the keypad, returns you to "measurement" mode.
- Within any one menu, the ◀ and ▶ keys are used to change page. These keys may also have a contextual function. If this is the case, a reminder of this function will be provided at the bottom of the screen page, such as the choice of screen in measurement mode, which is displayed by default.
- After powering on the Uf 821, the screen displays the page that has been selected as priority. To choose this default screen, position yourself on it and define it by default by pressing on the "B" key.

- To scroll through the measurement screens, use the ▲ and ▼ keys.
- To access the other menus, press the "Fn" key, then successively press the ◀ key, or browse using the ◀ and ▶ keys.
- To enter a menu, press ▲ or ▼.
- To change page, press "A" or "B".
- To change a row, select it using ▲ or ▼ and change the value using ◀ or ▶.
- If no key is pressed for approximately one minute, the Uf 821 automatically returns to "measurement" mode and to the display chosen as priority using "B".
- For a given parameter, the value to be applied is defined using the ▶ (increase) and ◀ (decrease) keys. Pressing and holding one of these two keys accelerates the increase or decrease.

1.11 Operating lights

Two LEDs are present on the front panel:

- **Blue measurement LED:** indicates whether or not the flow meter is in measurement mode (as opposed to configuration mode).

A flashing LED indicates normal operation.
An LED which is fixed on or off indicates abnormal or interrupted operation.

Warning: the flow meter may be in measurement mode (inputs-outputs, function loggers) without the probes being connected.

- **Red, orange or green Communication LED:** indicates the status of the external communication of the flow meter (serial link or USB).

Flashing green light for each dialogue on the serial link.
Long red flashing light on each dialogue error on the serial link.
Fixed orange light when the flow calculation is in degraded mode or when a related function is faulty.
Fixed red light when the flow calculation is faulty.

1.12 Screen

- LCD: graphic (14 rows x 20 characters).
- Backlighting: permanent or timed.

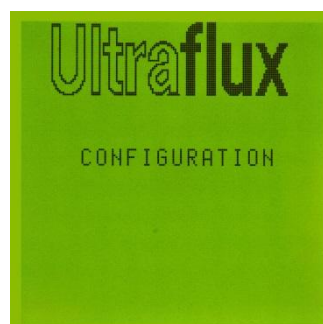

1.13 Functions

- **Data recording:** The flow meter is used to record the data measured (logger function). Up to 30 variables can be recorded (for example: average flow, minimum flow, maximum flow, water level). A total of 530,000 readings can be recorded. The frequency and sequencing of the recordings can be adjusted.
- **Echo display:** It is possible to display the measurement echo for each chord, which allows you in particular to check the quality of the measurement and directly view the effect of certain corrective actions (positioning and alignment of the probes, adjustment of the settings, cleaning of the probes, etc.).
- **Four flow volume totalisers** which can count the positive flows, negative flows or total flows, regardless of their sign.
- **Filtering of the measurement** using a first-order filter allowing non-significant flow fluctuations to be smoothed.
- **Storage of the measurement** in memory in the event of a momentary loss of the echo (due, for example, to the passing of air bubbles) or other faults (adjustable storage interval).
- **Deletion of the bottom of the scale** if the flow is below a programmed value,
- **Zero readjustment** if you have a full pipe with a strictly nil flow.
- **Function engine.**

1.14 Performance of the flow meter

- Uncertainty over measured speed: up to ± 0.5 %.
- Repeatability: up to 0.1 %.
- Linearity: up to 0.1 %.
- Typical uncertainty on the flow rate calculation: from 0.5 to 5 % depending on the application and the number of chords.

Important: The accuracy of the measurement also depends on the accuracy with which the geometry of the measuring point is measured, the dimensions of the probe pairs, the distance between the probes and the length the wave has to travel between two probes. An inaccuracy on one of these values may compromise the accuracy of the measurement.

1.15 Cleaning the flow meter

The box may be cleaned with water, diluted alcohol or detergent using a sponge or a soft cloth. Do not use abrasive materials or solvents.

1.16 Recycling the flow meter

In the context of decree no. 2005-829 dated 20 July 2005 and decree no. 2009-1139 dated 22 September 2009 relating to the collection, treatment and disposal of electrical and electronic equipment, batteries and accumulators in France, Ultraflux delegates the responsibility for financial and also logistical recovery to the user, who will manage their own waste. The separate collection and recycling of your waste at the time of its disposal will help to preserve natural resources and guarantee recycling that is least harmful to the environment and human health. For further information on the closest recycling centre to your site, contact the local authority or disposal service for the waste material in question.

1.17 CE marking

The Uf 821 complies with CE certifications:

EN 55016-2-1	Measurement of conducted emissions Criterion A
EN 55016-2-3	Measurement of radiated emissions from 30 MHz – 6 GHz
EN 61000-4-6	Immunity to induced conducted disturbances Criterion B
EN 61000-4-2	Immunity to electrostatic discharges Criterion B
EN 61000-4-3	Immunity to radiated electromagnetic fields Criterion A
EN 61000-4-4	Immunity to rapid transients in bursts Criterion B
EN 61000-4-5	Immunity to shock waves Criterion B
EN 62311	Human exposure to electromagnetic fields
IEC 60529	Degree of protection provided by enclosures (IP)
IEC 61010-1 (2010)	Electrical Safety – Low voltage directive (DBT)

CHAPTER 2: SAFETY INSTRUCTIONS

2.1 Using the flow meter

The flow meter, equipped with ultrasonic probes, is used to measure the flow of fluid (gas or liquid) in a pipe. It is important to configure the flow meter correctly for its measurement results to be correct. You are recommended to call on qualified staff from Ultraflux to ensure this is the case. This is strongly advised if your equipment is used to regulate a process, intervene in a monitoring system, or in the case of other applications for which an incorrect flow measurement could lead to risks.

In normal operation, the flow meter must not heat up to a level liable to cause burns. It is not necessary to take any particular precautions to allow it to cool. Should the temperature of the unit rise abnormally, it is recommended to power off the flow meter and call Ultraflux for expert advice. In the event of a fire inside the flow meter, power it off without opening or touching it, then call the competent services in order to secure the premises.

The flow meter must not be used beyond the possibilities and specifications given in this manual. The flow meter must be stored in a dry place, with the packaging provided by Ultraflux in order to protect the parts liable to be damaged by a shock. It is advised to wear PPE (personal protective equipment) suitable for handling and installing the apparatus.

The flow meter must only be modified or disassembled by Ultraflux personnel. Ultraflux accepts no responsibility should this rule not be respected.

The connectors must only be connected or disconnected with the power off and the equipment isolated.



For wiring and unwiring operations relating to function or maintenance, **the protective ground must be connected first and disconnected last.**



Where the unit is installed with a 90-260V ac power supply, the mains terminal block protective cover should be closed and the two retaining screws tightened. The purpose of this cover is to prevent any risk of electric shock in the event that the unit is handled when live with the lid open (for example when a USB cable is connected for configuring or reading data).



The flow meter is designed for fixed installation and must not be connected to the mains with a plug-in cable (risk of an unidentified or poorly identified phase on a mains socket). It must be connected to a terminal board on which the phase is correctly identified.

Ultraflux accepts no responsibility for incidents which may occur following a failure to respect these instructions.

2.2 Equipment connected to the flow meter

Any equipment connected to the unit must comply with its associated standard with regard to safety and have SELV circuits (double insulation between primary and secondary). All equipment connected to the flow meter must be disconnected before its protective ground is disconnected.

2.3 Symbols used on the flow meter

Symbols shown on the outside of the unit (labels or on the keyboard side):



User manual must be read before use.



The flow meter must be disconnected and the power switched off before opening the unit or connecting or disconnecting inputs and outputs.



EC marking indicates compliance with European Community requirements.



Dangerous voltages in the unit.



Hazard risk; please refer to the precautions in these user instructions.



The unit's protective ground must be connected.



Do not throw in the bin. Follow the recycling procedure indicated in these instructions.

Symbols marked on the internal panelling (labels):



Ground marking, Phase (L) and Neutral (N) on the protective cover of the mains terminal board.



Positive, negative and Ground terminals near to the low voltage power supply connection terminal board.

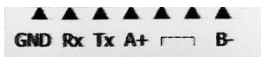

COM terminal board label: RS232 and RS485 wiring.

S7	S8	S5	S6	S3	S4	S1	S2
Corde 4	Corde 3	Corde 2	Corde 1				
Chord 4	Chord 3	Chord 2	Chord 1				

Descriptive label of terminals for connecting the probes:
S1 - S3 - S5 - S7: upstream chords; S2 - S4 - S6 - S8: downstream chords.

Module 4		Module 3		Module 2		Module 1	
A	B	A	B	A	B	A	B
-+	-+	-+	-+	-+	-+	-+	-+
21	43	21	43	21	43	21	43

Descriptive label of internal input and output module terminal connections (according to the optional modules ordered by the customer).

See paragraphs 3.6 & 3.8 on wiring of the above terminal boards.

2.4 Maintenance work on the flow meter

Work relating to maintenance on the flow meter must only be carried out by Ultraflux staff (SAV) and using only parts supplied by Ultraflux (*).

Only operations relating to installation and start-up may be carried out without the intervention of Ultraflux:

- attachment (to wall) of the flow meter,
- connection of the equipment ground,
- connection of the probes,
- wiring of the inputs and outputs (**),
- wiring of the COM port (RS232 / RS485),
- connection of power supply,
- communication of the unit via its USB port.

(*) Except for consumables used to attach to the wall (bolting), the connection of external items connected to the unit (cables and support brackets, apart from the probe cables as these are supplied with the probes delivered by Ultraflux).

(**) The number and type of inputs and outputs available correspond to the optional modules fitted during production of the Uf 821 by Ultraflux, depending on the options ordered by the customer.

2.5 Contact address

For any requests for information, please contact us at:

ULTRAFLUX

9, Allée Rosa Luxemburg

95610 ERAGNY

FRANCE

<http://www.ultraflux.net>

E-mail : ultraflux@ultraflux.fr

Tel.: 33 (0)1 30 27 27 30

Fax: 33 (0)1 30 39 84 34

2014 ULTRAFLUX S.A.

CHAPTER 3: INSTALLATION AND WIRING

3.1 General

The Uf 821 casing presents no particular danger to the user. Depending on the environment where the unit is installed, it is however recommended that you wear personal protection equipment during installation, including: gloves, safety boots, impact-resistant glasses.

It is recommended that you follow the installation method below, to avoid any risk of injury.

Installation must be done by or inspected by Ultraflux to ensure that the unit is water-tight and will operate correctly.

Important: Avoid installing the Uf 821 close to a frequency converter. If this cannot be avoided, interference filters must be installed. It is highly recommended that you contact us if this situation arises.

It is also recommended that you separate the measurement and power cable trays.

3.2 Wall mounting and space requirement

Make fixing holes in the wall which should be of sufficiently solid construction. First, attach the wall plate supplied with the unit. The Uf 821 is then mounted on this plate, using the notches provided. Finally, lock the unit vertically against the lower return on the wall plate, using the M4 screw supplied.

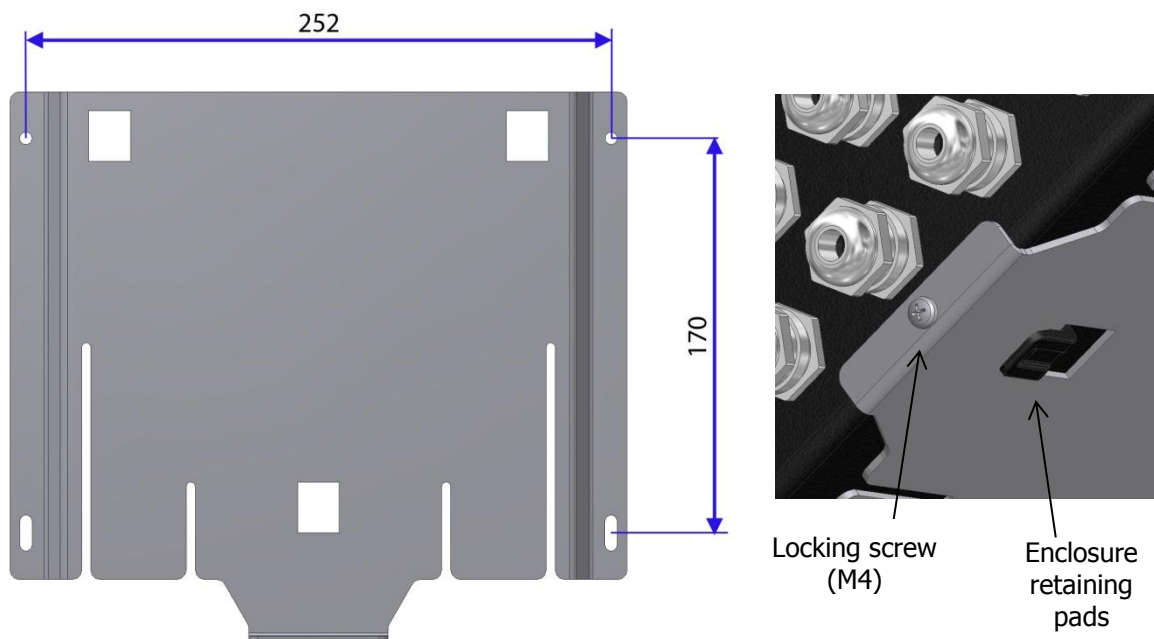

The dimensions shown are the drilling centres. Use 4 to 5 mm diameter screws and plugs suitable for the type of material.

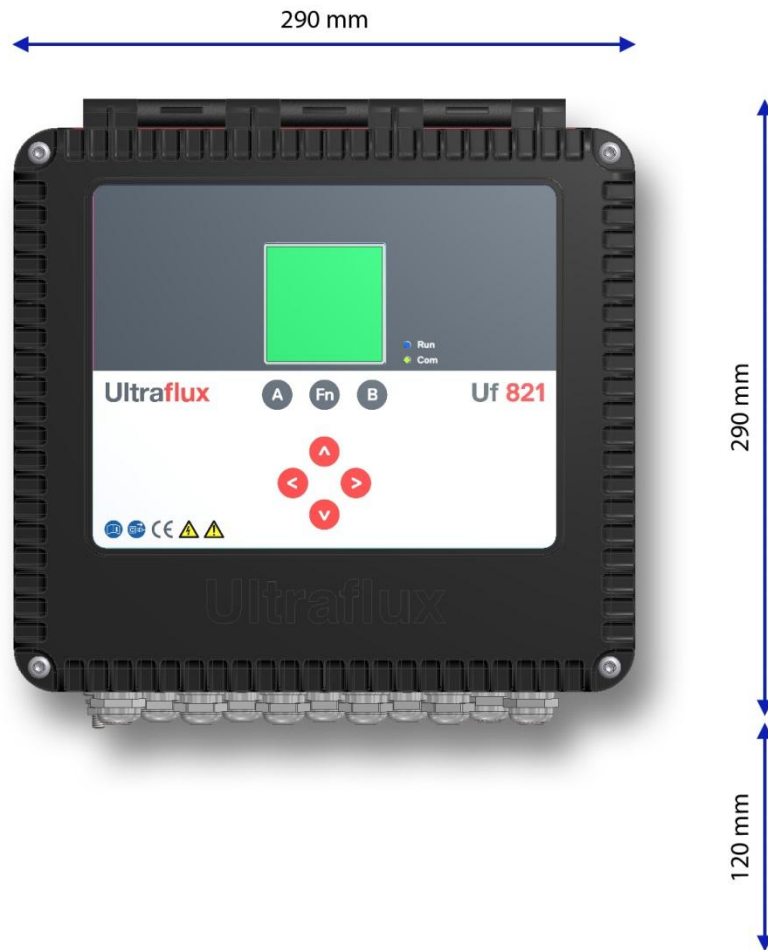

Overall depth, including wall-mounting plate: 100 mm.

120 mm of clear space must be left below the glands to allow for connecting the cables.

3.3 Using the cabinet

The Uf 821 enclosure was designed for installation on a wall only, where wiring operations are simpler, and following the order of work given below:

- Start by fixing the wall mounting plate.
- Attach the flow meter to it before opening the enclosure to do the wiring.
- First of all, connect the protective earth.
- Remove the lid screws and open the enclosure to the desired angle (the return spring on the lid stay will hold it in position).
- Pass the various cables through the cable glands.
- Connect the cables to the various terminal blocks (disconnect them to make the work easier).
- Secure the cables using ties attached to the inside of the metalwork.
- Close the lid and tighten the fixing screws (tightening torque recommended to obtain an IP67 seal: 200 Nxc.m).
- Tighten the cable glands to the torque indicated in section 1.4 "Sealing".

3.4 Using the lid stay

With the enclosure in position on the wall, the stay will hold the lid at various opening angles, using a series of notches (A). The return spring positions it automatically in the notches when the lid is opened,

To close the lid again, lift the stay and position it in the lowest notch (B).

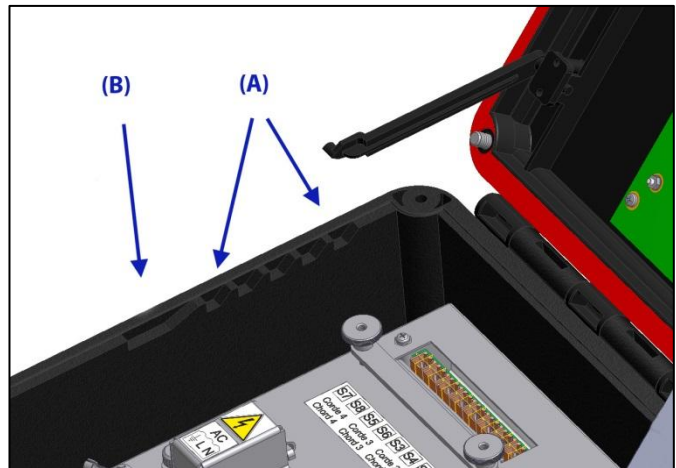

3.5 Tool-free removal of the lid

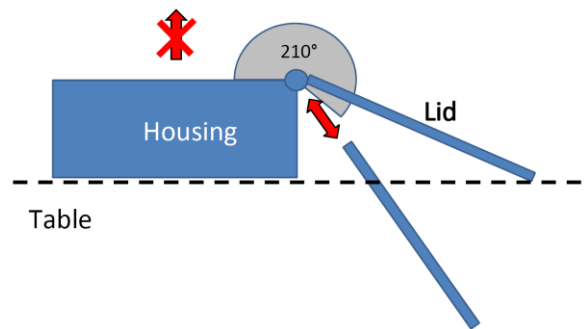
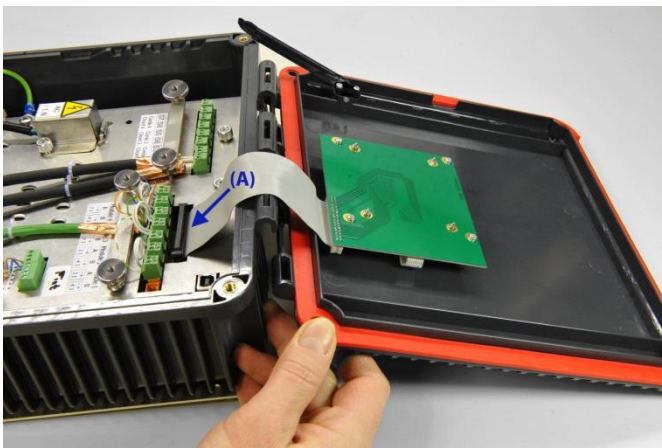

The lid cannot be removed during work on the unit, while it is fitted on a wall or placed on a table.

However, to facilitate maintenance operations, the hinge on the enclosure allows the lid to be removed without the use of tools, when it is open at an angle of more than 210°. To replace the lid on its hinge, it must again be positioned at an angle greater than 210°.

It is therefore recommended that you **avoid picking up the Uf 821 when open, holding it by the enclosure alone.**

Before removing the lid, it is essential that the **Uf 821 is disconnected from the power** and that the **ribbon cable is also disconnected** (ref (A) in the left hand illustration). The ribbon cable must also be re-connected with the power off.

3.6 Wiring instructions

Wiring must be carried out by a person with electrical accreditation. The flow meter must be powered off before installing or uninstalling. The isolation devices must be locked and tagged. The wiring must comply with the diagrams provided for the power supply and for the inputs/outputs.

It is sometimes necessary to protect the inputs/outputs, the power supply and the ultrasonic chords. You are strongly recommended to contact Ultraflux to obtain a diagnosis on this point. Ultraflux accepts no responsibility in the event of the incorrect use of the flow meter, and in such cases, the Ultraflux guarantee would not be valid.

3.7 Connection to the protective ground (to be carried out first)

For the ground connection, it is recommended to use a copper braid. When choosing the braid, it is important to adhere to the following rule: Length / Width < 3. At the end of the Uf 821 ground connection contact there should be an M6 stud bolt fitted with appropriate washers and nuts. In all cases, the section of the conductor used must be greater or equal to that of the device's power supply cable conductors (see §3.8.1).

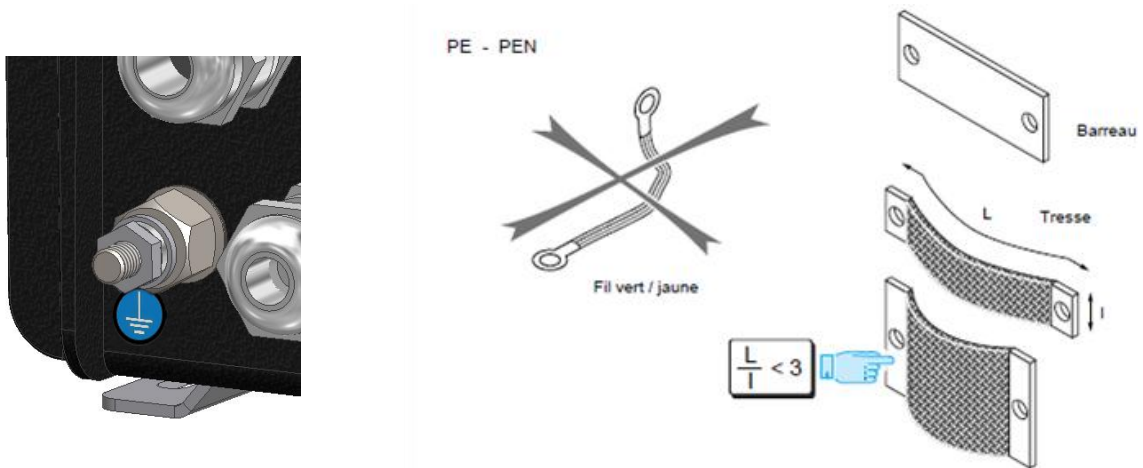

3.8 Wiring the Terminals

Apart for the USB connector, all connections require plug-in terminals that may be unplugged from the machine if this makes it easier to connect the conductors. With regard to connection of the ultrasonic probes, please refer to the example below.

3.8.1 Power supply

Mains power supply:

The mains cable must have a minimum conductor size of 3 x 1.5 mm² and comply with IEC standard 60227 or 60245. Its external diameter must be between 7 and 10 mm so that it is held firmly in the cable gland provided for this cable. The green/yellow conductor must only be used for the earth connection.



Connect the mains cable according to the connections shown on the protective cover. If multi-strand conductors are used, it is essential that they are fitted with crimp lugs, preferably insulated with a plastic sleeve. Remember to replace the protective cover after connecting the mains cable and secure it in place using the captive screws provided.

Low voltage supply:

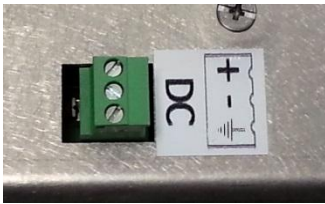

Polarity for low voltage connection. Earthing here is optional but if it is provided on the external power supply and its cable, it should preferably be connected. Recommended outside diameter for the cable: 7 to 10 mm.

3.8.2 Ultrasonic chords

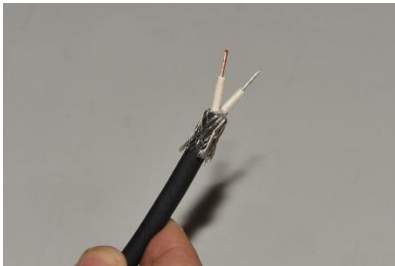

Unsheath a length of cable of between 10 and 15mm and bend back the ground braiding as shown opposite. Next, strip a length of about 5 mm of the conductors. Whilst doing this, note the colour difference of the two conductors: on the Twinax cable, the one is a galvanised colour and the other copper-coloured.

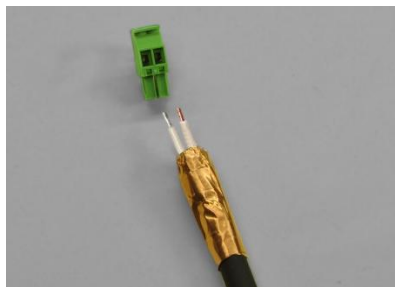

Cover the ground braiding with copper tape to prevent the threads of the ground from becoming loose and thus causing short-circuits. After passing it through the cable gland of your choice, connect the probe cable to the terminal board (disconnect the machine if this makes the operation easier), taking care always to connect the copper-coloured conductor on the same side on the terminals.

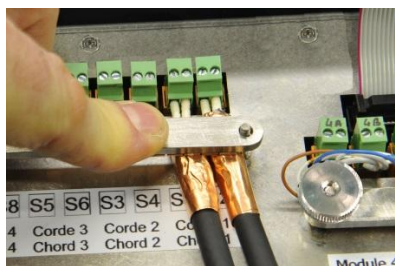

Connect the terminals to suitable positions, then place the shield connection jumper.

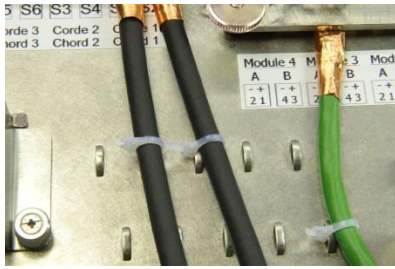

Use the loops pressed out of the metalwork to fit ties to secure the cables. There are two rows of loops available, to be used according to the number of ultrasonic chords connected, and also to secure other cables.



Only tighten the knurled nuts at the end, ensuring the shield connection jumpers are correctly secured, avoiding pressure exertion on the contact plates placed below these jumpers.

3.8.3 Input/output terminals

The RS232/485 communication and inputs/outputs must be connected to the terminals provided for this, after passing the cables through cable glands the furthest on the right. It is recommended to use at least category 5 shielded cable of folded twisted pair-type. The cable diameter should be between 6 and 12 mm.

To connect the shielding, it is recommended that the same precautions are followed as for the ultrasonic chords (copper tape). Shield connection jumpers are provided for each of the cables.

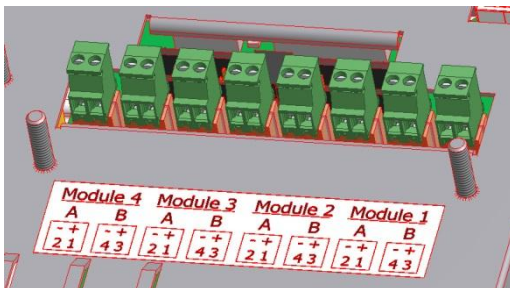

The input and output module terminals are identified by a label indicating their pin configuration. One to four modules are fitted by Ultraflux in the workshop depending on the options ordered by the customer.

After checking that these input/output modules have been actually activated through the CONFIGURATION menu, their allocation to the different connectors (1/A to 4/B) is available in the input and output configuration menu. More often than not, the modules furthest to the right (module 1, etc.) correspond to single 4/20 mA outputs and the ones next to this, to double relay modules.

Please refer to the following tables for the wiring to be carried out according to each type of module.

1) Wiring of the current output modules

Terminal pin configuration:

Pin	Function
1	Current (+)
2	Current (-)
3	---
4	---

2) Wiring of the current input modules

Terminal pin configuration:

Pin	Function
1	Current A wire 1
2	Current A wire 2
3	Current B wire 1
4	Current B wire 2

3) Wiring of the voltage input modules

Terminal pin configuration:

Pin	Function
1	Voltage A (+)
2	Voltage A (-)
3	Voltage B (+)
4	Voltage B (-)

4) Wiring of the relay modules

Terminal pin configuration:

Pin	Function
1	relay A
2	relay A
3	relay B
4	relay B

5) Wiring of the temperature modules

Note: this is a double location module

The sensors Pt 100 and Pt 1000 can be wired in different ways:

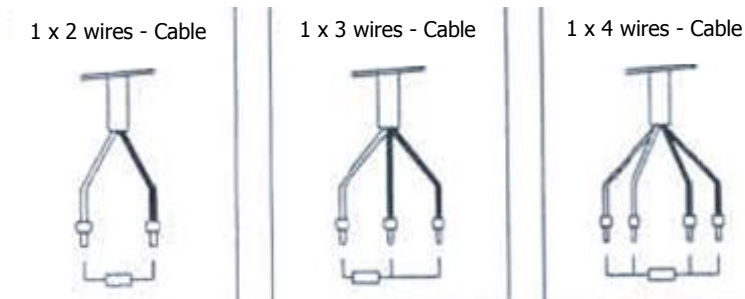

The most complete wiring is that using a 4-wire sensor:

Pin	Function
1	red wire 1
2	white wire 1
3	red wire 2
4	white wire 2

Please note: for 2- or 3-wire cables, just use "bridging" to make up for the missing wires. In the 3-wire version, a white wire is missing: simply bridge the two white wires 1 and 2 and place the white cable on the "white wire" pin.

Please note: To ensure good measurement quality, it is recommended to use shielded platinum probes. The shield connection is ensured by the ground connection jumper provided on the internal panelling.

3.8.4 Communication terminal board

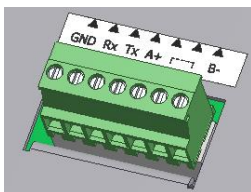

A common terminal board is provided for connecting the RS232 or RS485 communication. Only one type of communication must be used at a time. With regard to the RS485 network, this must end in a load resistor at each end of the line, especially if the cable is long. This resistance is planned for on the electronic card; simply add a jumper between points 5 and 6 to connect it.

1) RS232 mode wiring

Pin	Function
1	GND
2	Rx UF 821
3	Tx UF 821
4, 5, 6, 7	not used

2) RS485 mode wiring

Pin	Function
1, 2, 3	not used
4	A+ RS485 (=Z)
Jumper between 5 and 6	To use the load resistance
7	B - RS485 (=Y)

Type of cable to be used: same recommendations as for the inputs/outputs.

To connect the shielding, it is recommended that the same precautions are followed as for the inputs/outputs and the ultrasonic chords (copper tape). Use shield connection jumpers designed for this purpose.

3.9 USB Connection

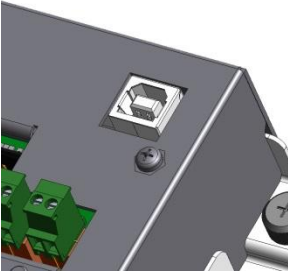

Use of the USB port requires the Uf 821's lid to be open beforehand. The lid will be held at the required angle by the stay.

CHAPTER 4: IMPLEMENTING A MEASURING POINT

There are 5 main steps to commissioning a measuring point and these must be followed very carefully. We would also like to remind you that Ultraflux can help with commissioning of your flow meters (for further information on this service, please contact us).

4.1 Choosing the measurement location

We highly recommend that you follow the instructions given in our document "Flow measurement by transit time difference".

As a reminder, the main precautions to be taken are as follows:

- Choose a measurement location providing straight lengths upstream and downstream of around 10 times the width of the channel or the river.
- Also choose a location where there is little aeration of the water. You should therefore avoid locations immediately downstream of:
 - a waterfall or a weir,
 - a screw-type pump,
 - a highly aerated grit chamber/oil separator,
 - an aerobic decantation installation,
 - a permanent tunnel aeration device.

4.2 Installing the probes

Given the many attachments and supports that are possible for wet probes (for open channels and rivers), we will not go into each of them in detail, but rather list the general principles and prerequisites for smooth operation of the installation.

1. When positioning the probe supports:
 - Respect the "axis diameter" when installing the supports. This value is provided by Ultraflux and is calculated based on the range of velocities expected at the measuring point.
 - Position the probe supports on each bank so that the ultrasonic chord(s) is (are) parallel to the water level (each probe the same distance from the water level).
2. When fixing the probe support:
 - Make sure that the position of the probe can still be adjusted (directional probes only).
 - Make sure that the attachments points are secure.
3. When aligning the probes:
 - Align the probes as far as possible using a laser sight or a rifle scope (depending on the distance and the meteorological conditions),
 - Once the work has been completed, make sure that the probe alignment mechanism is locked in place.

Comment: Probe alignment can be checked when the electronics have been put in place. You can then simply view the relative gain on each chord in your flow meter.

4.3 Measurements to be taken on site

4.3.1 Topography of the site

For future configuration of your Uf 821, the following points should be measured:

- Geometry of banks upstream, downstream and level with the measuring point,
- Pile (or probe support) position and the position of the ultrasonic probes,
- Floor profile (bathymetry),
- Water level on the water level gauge (day, date and time of operation).

4.3.2 Determining the different levels in relation to the stream

For future configuration of your Uf 821, the following measurements need to be taken on site in relation to the water level:

- The level probe(s),
- The velocity measurement chords (ultrasonic probes).

4.4 Analysing and processing data measured on site

In preparation for configuring your meter, produce the site plan and the plan of the different heights using the data collected.

Follow the 5 steps below to produce your 2 plans.

1. Trace the position:
 - Of the probe supports
 - Of the water level gauge
 - Of the banks
2. Work out the main axis of flow
3. Project the position of the probes onto this axis
4. On the plan, measure:
 - The distance between probes "L"
 - The axis diameter
5. Produce the plan of the different heights:
 - Of the water level gauge
 - Of the velocity measurement chords (ultrasonic probes)
 - Of the level sensors

4.5 Transferring the data collected to the converter

All of the data collected previously (points 4.3 and 4.4) must be transferred to the converter. There are two ways you can do this:

- Using the PC software for your Uf 821 (see Chapter 7),
- Directly in your Uf 821's interface (see Chapter 5).

CHAPTER 5: USING AND CONFIGURING THE Uf 821

5.1 Using the Uf 821

The Uf 821 has a screen and a keypad which can be used to configure and view measurements as they are taken. LEDs indicate the status of the measurement and of the flow meter communication.



5.1.1 Operating mode

Uf 821 flow meters have 2 different operating modes:

- Measurement Mode (flow rate, velocity, gain, quality index, etc.) grouping together the measurement screens,
- Configuration Mode (section description, logger, etc.) grouping together the configuration screens as well as the echo display screens (display of electric pulses generated by the probes).

5.1.2 Keypad

The diagram below summarises the navigation procedure between the various screens and relating to the machine's "Measurement" and "Configuration" modes (including the echo display):

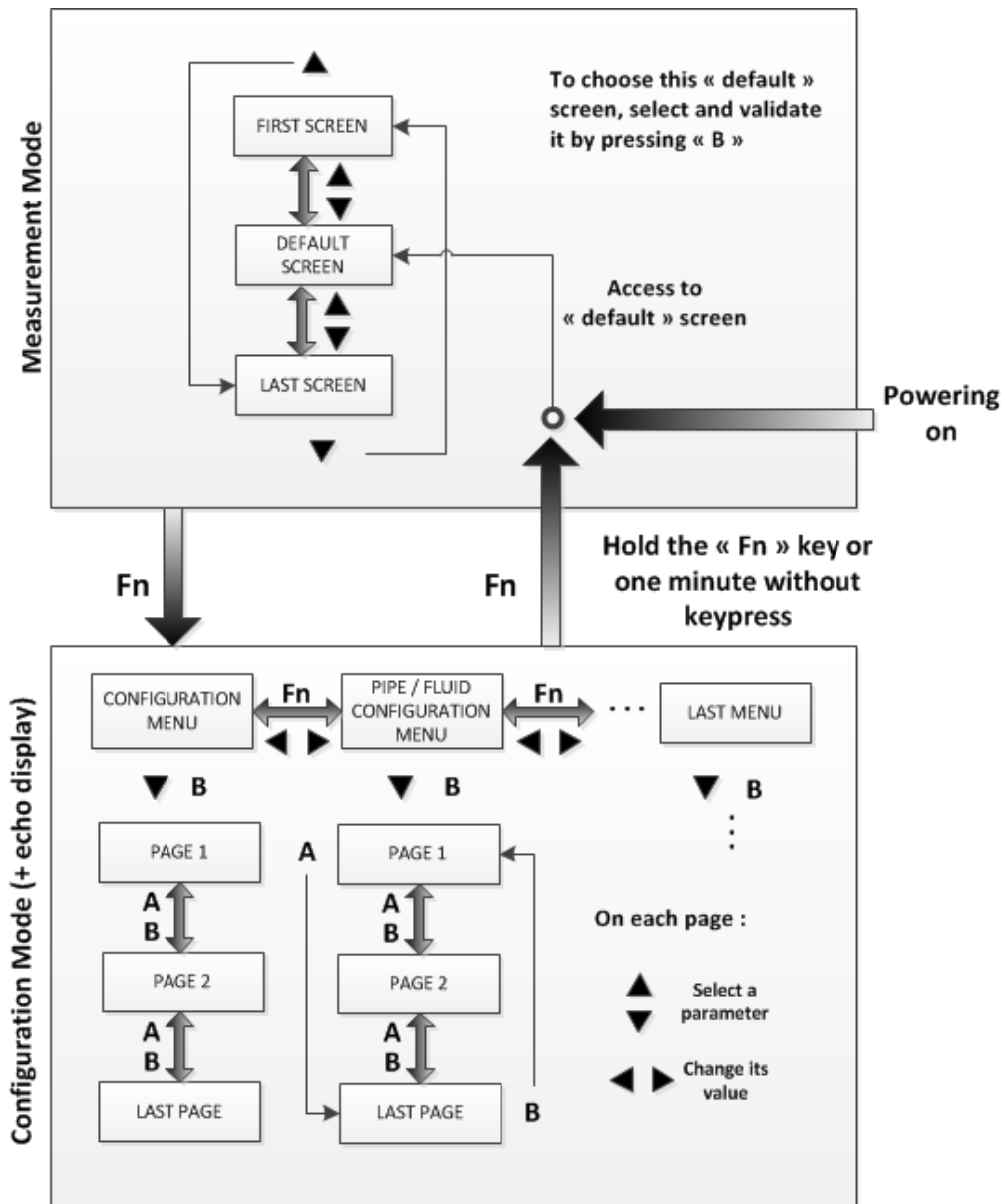

"Configuration" Mode:

- To move from one type of menu to the other, press the "Fn" (function) key or the ◀ and ▶ keys.
- To enter the first page of a menu, press the ▼ key or the "B" key. To then move down one page, press the "B" key. To move up one page, press the "A" key. To change a parameter, select it using ▲ or ▼ and change its value using ◀ or ▶.

N.B.

- If you are on the first page of a menu, pressing "A" causes selection of the last page of the menu.
- If you are on the last page of the menu, pressing "B" returns you to the first page.

- To change a parameter on a page, select it using ▲ or ▼ and change its value using the keys ► (increase) and ◀ (decrease). Pressing and holding one of these two keys accelerates the increase or decrease.

N.B.

- If you are on the first parameter of a page, pressing ▲ will send you to the last parameter of the previous page (and conversely if you were on the last parameter of the page).
- The same last page / first page loop process is carried out as for changing page using "A" and "B".
- Holding down the "Fn" key, or allowing approximately 1 minute to pass without using the keypad, returns you to "measurement" mode (by default, to the previously selected screen).
- Special feature of the "echo display" menu: the flow rate measurement is interrupted when the echo display is being used.

"Measurement" Mode:

- After powering on the Uf 821, the machine moves into measurement mode after a few seconds and displays the screen (or page) that was previously selected as priority. To choose this "default" screen, select and validate it by pressing "B" in *Measurement* mode.
- To scroll through the measurement screens, use the ▲ and ▼ keys.
- Pressing "Fn" switches the machine to Configuration mode on the "Configuration" menu.

5.1.3 LEDs

There are two LEDs on the front panel:

- *Blue measurement LED*: indicates whether or not the flow meter is measuring.
 - A flashing LED indicates normal operation.
 - An LED which is fixed on or off indicates abnormal or interrupted operation.

Warning: the flow meter may be in measurement mode (inputs-outputs, function loggers, etc.) without the probes being connected.

- *Red, orange or green communication LED*: indicates the status of the external communication of the flow meter (serial link or USB).
 - Flashing green light for each dialogue on the serial link.
 - Long red flashing light on each dialogue error on the serial link.
 - Fixed orange light when the flow calculation is in degraded mode or when a related function is faulty.
 - Fixed red light when the flow calculation is faulty.

5.2 Main configuration elements

5.2.1 Geometric and physical definition of the measuring point

1) Composition of a measuring point

A measuring point consists of:

- an open channel measurement section (channel or river),
- a description of the hydraulic profiles,
- a fluid,
- one or more ultrasonic chords,
- up to four level sensors (which may or may not be provided by Ultraflux).

2) Reference systems used

Two reference systems are used:

- The customer reference system: the one used in measurement mode to display the water level. "Level" is used to refer to all elevations measured in this reference system,
- The section description reference system: the one used to describe the form of the channel or the river. "Height" is used to refer to all elevations given in this reference system.

Example: The water is at 150 mm on a water level gauge. The flow meter will display the level of the water surface in the customer reference system.

However, to describe the section, you may wish to take the bottom of the channel as a reference, with the water level to be displayed in relation to the customer reference system. The joint use of the two reference systems then involves reference planes.

3) Definition of the reference planes

Each channel is defined by a set of trapeziums. Each trapezium is defined by:

- height at top/height at bottom,
- width at top left and right/width at bottom left and right.

To define the section of the channel, two reference planes are used, one for the heights (H0) and one for the width (W0). The form of the channel or the river is broken down into sections. Each section represents a part of the trapeziums. The heights and widths of the trapeziums are measured in relation to two reference planes.

Example:

For the following sections:

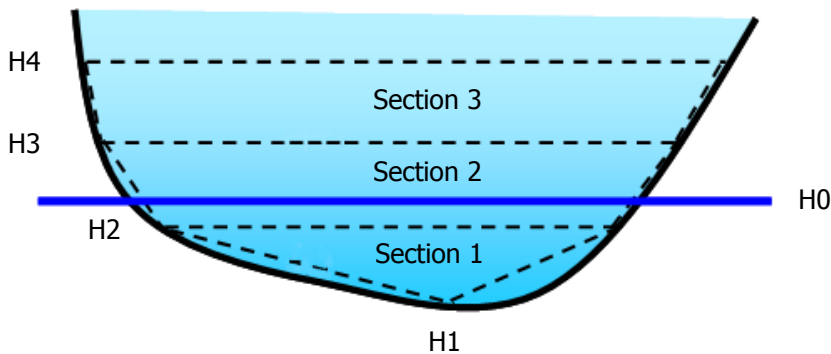

The section heights are defined as follows:

- H1= - 0.5 m
- H2= - 0.2 m
- H3= 1.2 m
- H4, H5 H20 (if defined) = to be determined

The elevations may be negative, null or positive depending on the H0 chosen.

The widths meanwhile are defined with regard to a vertical plane W0:

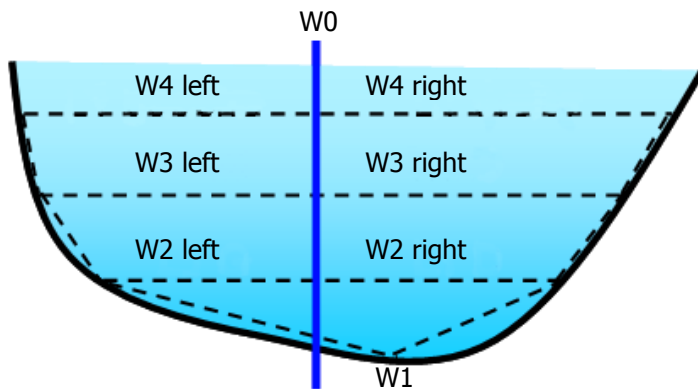

As for the heights, the widths may be negative, null or positive with regard to this plane.

Comments:

- The highest point must be greater than the maximum foreseeable water level. If the water exceeds this height, the entire area located above this last point is not taken into account.
- For rather complex sections (e.g. semi-circular outfall sewer with cunette), it is important to surround the discontinuities with two elevations close together.
- It is not compulsory to define 20 pairs of points. The widths of the unused points may be set to 0.

4) Correspondence between customer reference system and section description reference system

To connect these two reference systems, the elevation must be defined between the zero of the level and the plane H0.

Level (water level gauge)

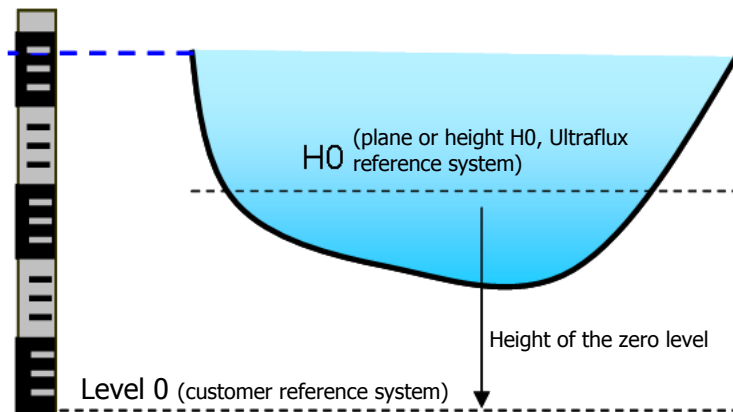

Three scenarios can be envisaged:

- If the zero level of the water level gauge is **below** the plane H0, the height of the zero level has a **negative** value (see figure above),
- If the plane H0 and the bottom of the water level gauge correspond to the river bed, the height of the zero level is 0,
- If the plane H0 is defined as being the surface of the water at a reference height of 26m NGF (General Levelling of France), the height of level zero (therefore 0 NGF) has a value of -26m since, in the section description, the plane is located at a height of -26m NGF.

Note: The open channel pipe is defined by its section, its hydraulic profile and the position of the ultrasonic chords.

The number of chords must be determined based on

- the required accuracy
- the amplitude in the variation of the level (since the probes must be submerged in order to operate)

For all of these technical points, consult Ultraflux if necessary.

5.2.2 Number of channels

Note: for multi-channel flow meters only, it is possible to define the number of channels to be managed by the flow meter. The geometric and physical description of the measuring point must then be produced for each channel.

In the case of several channels, the channels are named in alphabetical order (A, B, etc.). Qa, Qb, etc. are the flows calculated for each channel. Qt is the total flow.

5.3 Configuring the Uf 821

The configuration mode for the flow meter is divided into three levels:

- **Simple:** simplified configuration for basic use of the flow meter.
- **Normal:** configuration allowing more detailed use.
- **Advanced:** mode allowing complete adjustment of the flow meter settings. This mode is reserved for users with detailed knowledge of the transit time difference flow measuring technique and with some idea of hydraulic concepts.

The level can be changed by going to the menu Configuration / Settings / Simple, Normal or Advanced.



This menu is also used to activate functions such as

- the logger,
- the inputs/outputs,
- the totalizers.

To activate these options, position the cursor on the line corresponding to the required option and use the < and > keys.

5.3.1 Flow meter menu

Depending on the type of flow meter and the configuration mode selected (simple, normal or advanced), the flow meter menu may change. Below is a non-exhaustive list of the sections for the flow meter:

- **CONFIGURATION:** configuration of the operating modes, the registration name, the JBUS/MODBUS characteristics, configuration management, etc.
- **PIPE/FLUID SETTINGS:** settings for the type of fluid, the pipe, the chords, the geometry of the chords of the measuring point, etc.
- **DESCRIPTION OF SECTION:** settings for the section of the channel or the river.
- **LEVEL SETTINGS:** settings for the level measurement(s).
- **HYDRAULIC PROFILE:** settings for the hydraulic profile curve that the flow meter must use.
- **HEIGHT/VELOCITY SETTINGS:** settings for the height/velocity law in the event that the probes are all out of the water.
- **TOTALIZER SETTINGS:** settings for the totalizers.
- **INPUT/OUTPUT SETTINGS:** settings for the inputs and outputs.
- **LOGGER SETTINGS:** settings for the logger.
- **LINEARIZATION SETTINGS:** settings for linearization.
- **FUNCTIONS SETTINGS:** settings for the inputs for the function engine. This menu is only available upon request for specific applications.
- **ADVANCED SETTINGS:** settings for the simulation mode, the special probes, the specific codes for ultrasonic treatment, etc.
- **ECHO DISPLAY:** display of the echo signals of the ultrasonic probes.
- **FIRMWARE UPDATE:** update the firmware.

5.4 SIMPLE configuration mode

Below you will find the description of the menus, screen by screen, to guide you through the configuration of your flow meter.

5.4.1 "Configuration" menu

```
--- OPTION FILES ---  
  
Load Option File  
N 0:UF 8x1  
  
Save Option File  
N 0:UF 8x1
```

1) "Option Files" window

This window is used for loading and saving your configurations. The current configuration of the flow meter can be saved directly in the flow meter, or on a PC. Up to 11 configurations can be saved, numbered from 1 to 11.

To save the current configuration on the flow meter, select the configuration number under which you wish to save it. The saving of the configuration is then validated when you move to another menu page or after pressing and holding the **Fn** key.

To recall a configuration, enter the configuration number and validate this choice by moving to another menu page.

Make sure you remember to save the current configuration so that you do not lose it.

```
-- SETTINGS RESET --  
NO  
---Confirmation---  
NO  
  
----- SETTINGS -----  
Advanced  
  
----- MENU -----  
Totalizer = Enable  
Logger = Enable  
I/O = Enable
```

2) Reset

This command is used to reset the flow meter (restoration of factory settings).

3) Confirmation (of reset)

The flow meter is reset via a field requiring confirmation (protection against handling errors).

4) Settings

This command is used to change the flow meter's configuration level (Simple, Normal or Advanced).

5) Menu

Used to activate or deactivate:

- the logger,
- the inputs/outputs,
- the totalizers.

```
Code access = 0
LANGUAGE : ENGLISH
-- STATION'S NAME --
   UF 8x1
---- BACK LIGHT ----
      Timed
--CONNECTION 1: PC--
N JBUS/MODBUS: 1
Bitrate : 115200
```

6) Access code

The flow meter is initially delivered without an access code (access code is 0), allowing you to freely modify all the settings. The introduction of a valid code is used to prohibit the modification of the settings by anyone who does not have the code. The settings can then be viewed freely, but cannot be modified. The code comes into operation when the flow meter returns to measurement mode. The code must be entered in order to exit this mode. If the code is incorrect, the flow meter is locked for a few seconds. The time for which the flow meter is locked increases each time that an incorrect code is entered by the user.

Notes:

- The flow meter can be locked manually. Select the "Locked" field and set it to "YES".
- The code can be modified using the keypad (it is then defined using the < and > keys) or the serial link.

Important: For writing operations via the serial link or USB, the code must be "written" before any "writing" frame. The flow meter is automatically locked after 10 seconds without any "writing". Each incorrect attempt at entering the code increases the time before the next attempt can be made.

7) Language

The possible display languages are: French, English, Spanish, German, Italian, Portuguese and Russian.

8) Station name

Each flow meter can be assigned a label with up to 8 characters (registration number). The position of the current character is chosen using the ▼ and ▲ keys. To scroll through the characters, use the < and > keys.

9) Back light

The possible options are:

- ON: the back light is on for one minute after pressing any key, then remains dimly lit,
- TIMED: the back light is on for one minute after pressing any key, then goes off,
- OFF: No back light.

10) Connection

- Configuring the serial link
Enter the JBUS/MODBUS number of the flow meter (number assigned to the flow meter and to which it will respond in a JBUS/MODBUS query).
- Transmission speed (bitrate)
Enter the transmission speed that you wish to apply.

11) Time delay before return to "Measurement" mode

The flow meter automatically returns to the Measurement screens after approximately one minute. The modified settings will then be taken into account. This avoids the risk of forgetting to exit "Configuration" mode and needing to do further operations to return to "Measurement" mode.

5.4.2 "Pipe/fluid settings" menu

In "simple configuration" mode, access to the settings is restricted to the following sections:

1) Number of chords

Enter the number of chords used for your application.

2) Flow unit (unit Q)

Enter the flow unit to be displayed.

3) Flow graph

```

----- CHANNEL A -----
Nbr of chords = 1
-----General-----
Q Unit      =    m3/s
-----Graph-----
Q Period    =    1s
Q Qmin      =    0.0
Q Qmax      =   10.0
    
```

The flow graph is a screen in Measurement mode. It displays the changes in a specific magnitude in the form of a curve (see the possible dimensions below).

Enter the minimum and maximum limits of the dimension associated with the flow graph. These limits mark the boundaries of the vertical display of the flow graph.

The flow graph Period setting is used to define the time interval between two successive points. The possible values are: 1 s, 5 s, 10 s, 30 s, 1 min, 2 mins, 5 mins, 10 mins, 15 mins, 30 mins, 1 hr, 2 hrs, 6 hrs, 12 hrs and 24 hrs.

Example: If the period of the flow graph is 1 min, each point of the curve represents the average value of the dimension associated with the flow graph over 1 min and the whole screen shows the evolution of the flow over the last 144 minutes.

4) Type of fluid

In simple configuration mode, the fluid must be water at ambient temperature (cannot be modified).

5) Chord settings

The settings to be entered for the definition of a chord are as follows:

- the reference of the probes used,
- the length (in metres) between the faces of the two probes,
- the projected length (axis diameter) with regard to the axis of the channel or the river,
- the height compared to H0.

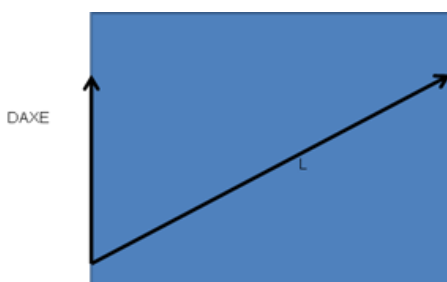

```

----- CHANNEL A -----
-----Chord 1-----
Probe      = SI1611/05
Length     = 1.34870m
Axial D.   = 1.12100m
CoefChord  = 1.000
Height     = 0.324m
DeltaT0    = 0.00ns
Seek Gain  = 30dB
Gain Max   = 96dB
U. Min     = -5.00m/s
U. Max     = 5.00m/s
immersion  = 100mm
    
```

5.4.3 "Section Description" menu

This menu is used to describe the section of the channel or the river.

1) Section description

```

----- CHANNEL A -----
DESCRIPTION SECTION
Pt  (H)      (L)
1 = 0.000 L = -2.450
    0.120 R = -2.010
2 = 0.120 L = -2.597
    0.241 R = -2.151
3 = 0.241 L = -2.744
    0.361 R = -2.291
4 = 0.361 L = -2.891
    0.482 R = -2.433
5 = 0.482 L = -3.037
    0.572 R = -2.572
    
```

For each chord, enter the elevation of the plane of the chord with regard to the plane H0 and the two widths with regard to the plane W0 (H0 and W0 defined in part 5.2.1, point 3). This section can be defined in 20 points.

It is possible to define a distance to the right and to the left of the plane W0.

2) Gauge offset

Level (water level gauge)

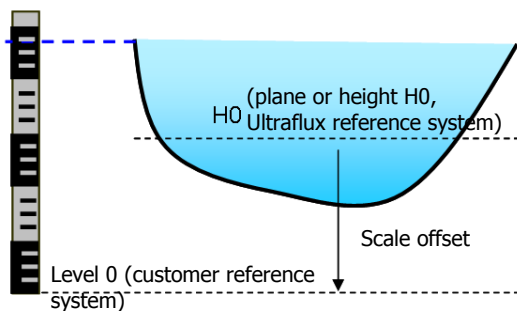

The gauge offset is the numerical value used to switch from the section description reference system ("height reference system") to the customer reference system ("level reference system").

3) Surface S0

```

----- CHANNEL A -----
Offset level
  m
S0 = 0.258 m²
    
```

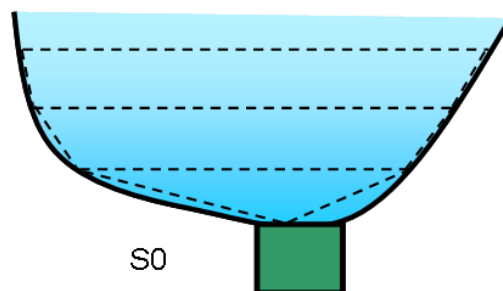

When the bottom of the channel or the river is difficult to describe in terms of section (for example if there is sand silting, pebbles, etc.), it can be estimated using parameter S0 which defines a surface of the section in which the velocity is constant.

If this parameter is positive, the calculation of the flow adds this section to the hydraulic section (erosion of the channel) and considers a constant fluid velocity equal to the lowest hydraulic section velocity.

If the value of S0 is negative, the value of S0 is deducted from the section and it is considered that so long as the wetted section is smaller than S0, the flow is null (siltation). The aim is to simulate silting of the channel.

5.4.4 "Level settings" menu

This menu is dedicated to configuring the level measurement.

The level measurement is essential for measuring the flow. In fact, ultrasonic probes are used to measure the average flow velocity of the fluid in the channel and the level is used to find out the surface wetted by the fluid in the section of the channel.

1) Number of level measurements

The Uf 821 can be used to manage up to four level measurements.

The menu below is used to select, for each level, the input channel which corresponds to the level measurement (for example, a 4-20 mA input):

```
----- CHANNEL A-----  
Number of level = 1  
  
----- Level 1 -----  
Input  
02-A
```

The measurement used to calculate the flow rate (priority measurement) is level 1. If this is faulty, the flow meter automatically switches to level 2.

Note: To measure a level, a simple solution involves using a current input. The flow meter will work out the level of water in which the sensor is submerged from the current measured. Simply configure the range of the sensor and the base of its scale. For further information on the configuration of inputs/outputs, see the chapter dedicated to this subject.

Comment: For a level sensor taking a downward measurement (for example, a measurement by ultrasound in the air), the range of the measurement entered in the flow meter must be negative.

5.4.5 "Hydraulic Profile" menu

1) Description of the hydraulic profile

The vertical hydraulic profile is described using 20 sections.

Each section is defined by its lower and upper elevations and by its hydraulic coefficient (see this concept in our document "Flow measurement by transit time difference").

The value of this coefficient may be fixed section by section (absolute mode) or may be calculated for each section based on the distance from the section to the surface.

The graph below shows the rest of the coefficients specified by standard ISO 6416 (indicates the existing relation between the average velocity V in the entire wetted section and the velocity measured by a chord submerged at d / D):

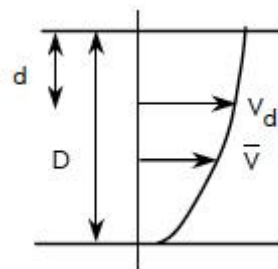
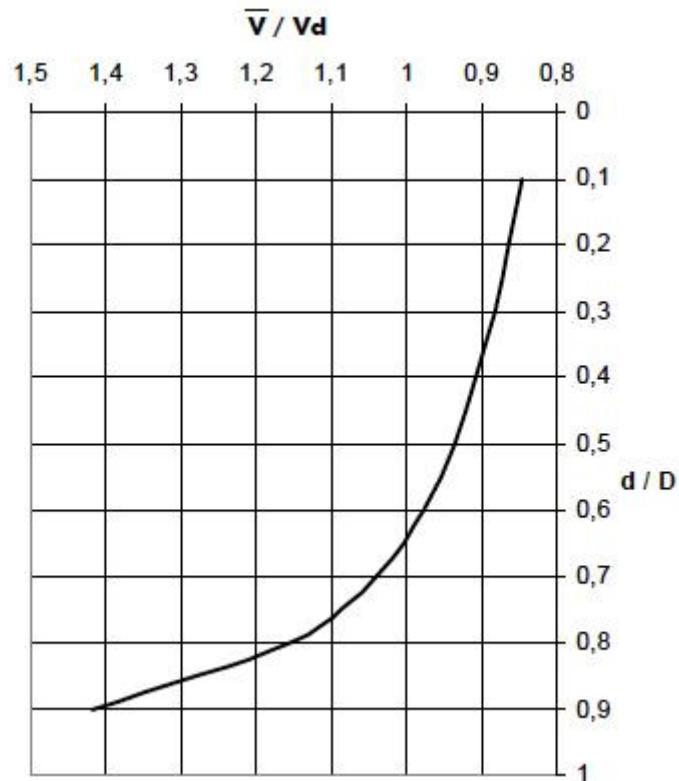

Comments:

- The deepest section is marked by the bottom of the channel or the river and by elevation no. 1,
- The sections describing the hydraulic profile are fully independent of the sections describing the measurement section.

2) Choosing the definition mode of the hydraulic profile

The hydraulic profile may be defined according to two modes:

- **Absolute mode**, in which the elevations marking the sections are specified in metres starting from the bottom of the channel or the river up until the maximum foreseeable height (point 1 = lowest elevation; point 20 = maximum foreseeable height) and in which the hydraulic coefficient of each section is fixed. This mode is particularly suited for narrow channels with an irregular section.

Important: In absolute mode, all elevations are specified with regard to the reference plane H0.

- **Relative mode**, in which the elevations marking the sections are specified as an immersion percentage (for example, point 1 = 95% immersion; point 20 = 0% immersion = surface), the hydraulic coefficient being calculated based on the depth of the section. This mode is more particularly suited to wide channels with a fairly regular section.

Select the required mode, absolute or relative.

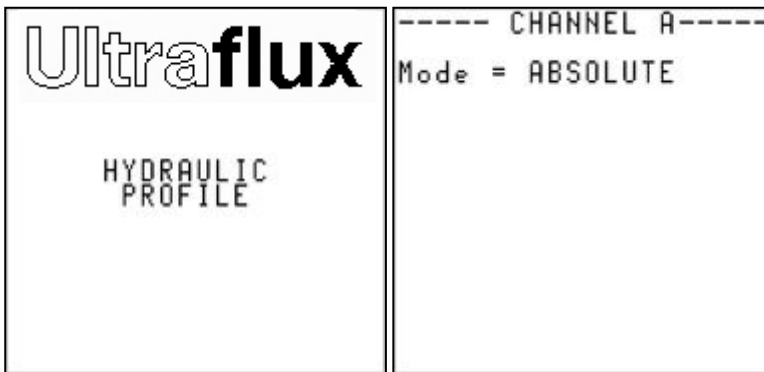

3) Absolute mode

Starting with the lowest elevation (Pt1), specify for each section the upper elevation of the section and the corresponding hydraulic coefficient.

CHANNEL A		
Pt	HEIGHT (m)	COEF.
1 =	1.0000	1.6000
2 =	2.0000	1.4117
3 =	3.0000	1.2611
4 =	4.0000	1.1544
5 =	5.0000	1.0884
6 =	6.0000	1.0339
7 =	7.0000	1.0005
8 =	8.0000	0.9778
9 =	9.0000	0.9555
10 =	10.0000	0.9336

CHANNEL A		
Pt	HEIGHT (m)	COEF.
11 =	11.0000	0.9211
12 =	12.0000	0.9000
13 =	13.0000	0.8895
14 =	14.0000	0.8895
15 =	15.0000	0.8871
16 =	16.0000	0.8833
17 =	17.0000	0.8850
18 =	18.0000	0.8845
19 =	19.0000	0.8837
20 =	20.0000	0.829

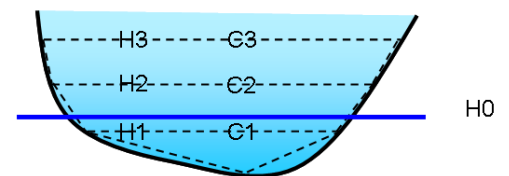

Comments:

- The elevation of point no. 20 must be greater than the maximum foreseeable level,
- For a given section, the velocity must be roughly constant.

4) Relative mode

Starting from the bottom, specify for each section the immersion percentage of the upper elevation and the corresponding hydraulic coefficient, the elevation of the last section being 0 (surface of the channel or the river).

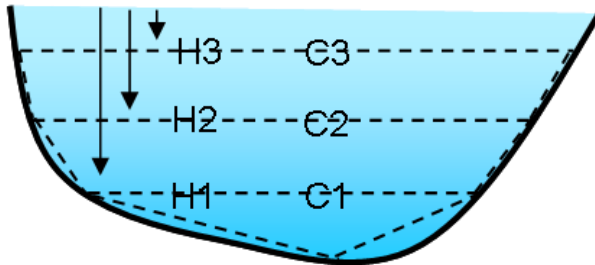

CHANNEL A			CHANNEL A		
Pt	IMMERS. %	COEF.	Pt	IMMERS. %	COEF.
1	9	1.600	11	45	0.921
2	95	1.417	12	40	0.908
3	90	1.261	13	35	0.895
4	85	1.154	14	30	0.882
5	80	1.084	15	25	0.869
6	75	1.039	16	20	0.856
7	70	1.005	17	15	0.843
8	65	0.978	18	10	0.830
9	60	0.955	19	5	0.817
10	50	0.936	20	0	0.804

Comment: By default, the breakdown of the hydraulic profile (into basic sections) proposed by the flow meter copies the one recommended by the ISO 6416 standard concerning the ultrasonic flow measurement in an open channel.

5.4.6 "Height/velocity settings" menu

1) Velocity profile in low water situation

When the level is below the lowest chord, the flow cannot be measured using ultrasound. It can however be estimated using a linear interpolation curve with 4 points, or by self-learning (automatic regression).

Velocity

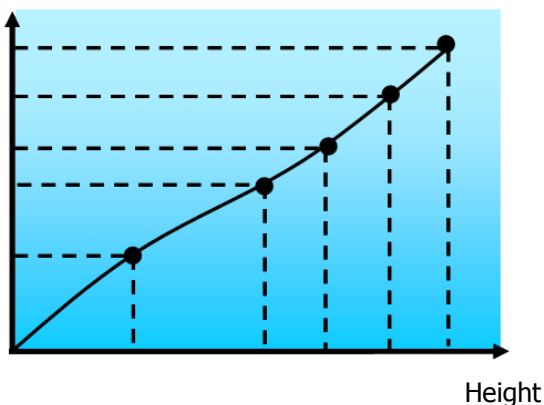

The settings to be indicated depend on the technique chosen:

- height/velocity curve:

```
----- CHANNEL A-----  
Calculation  
U=f(N)  
  
CONFIGURATION  
HEIGHT CELERITY  
Pt (m) (m/s)  
1 = 0.010 0.006  
2 = 0.037 0.025  
3 = 0.106 0.025  
4 = 0.231 0.097
```

Velocity (will be corrected with the flowmeter next update)

- automatic regression:

```
----- CHANNEL A-----  
Calculation  
Regress.  
  
Coef = 2.0480
```

It is possible to trigger a "learning" mode for this height/velocity law, which is done by automatic regression. The flow meter will then estimate what the height/velocity curve could be, taking into account the measuring points.

A coefficient can then be defined which will be used until the flow meter takes new measurements.

5.4.7 "Totalizer settings" menu (if activated)

```
----- TOTALIZER 1 -----  
Dir.= + Value =QA  
Pulse Weight  
100 m3  
  
----- TOTALIZER 2 -----  
Dir.=OFF
```

1) Activation and direction of metering

For each of the totalizers, the possible modes are:

- **OFF**: totalizer not activated,
- **+** : totalization of the positive flows, in other words going from the upstream probes to the downstream probes (see the wiring of the probes),
- **-** : totalization of the negative flows, in other words going from the downstream probes to the upstream probes,
- **±**: totalization of all flows, whatever the direction.

Note: In addition to flow rate totalization, other magnitudes from the function engine can be totalized if this is activated. Contact Ultraflux for further details.

2) Pulse unit and weight

Each activated totalizer emits an incrementation pulse (which can be returned on a relay output, see part 5.4.4, point 5) each time that the Pulse weight x Unit volume flows in the metering direction of the totalizer.

The possible units are (non-exhaustive list): 1 ml, 1 l, 1 m³, 1,000 m³, 1 Gal, 1 Bbl, etc.

3) Resetting a totalizer (if authorised)

When it leaves the factory, totalizer reset is blocked. This feature enables the totalizer to be used as a tamper-proof meter and can therefore be used for internal billing (mutually agreed by both parties).

Upon request and before dispatch, totalizer reset can be authorised.

On site, only an Ultraflux representative will be able to reset the totalizers.

To reset a totalizer (if authorised):

1. Switch to measurement mode (press and hold the **Fn** key) on the page of the totalizer concerned,
2. Press the **A** key until the totalizer that you wish to reset is displayed on the right,
3. Press the **B** key to reset the totalizer. A negative image of the pop-up menu is then displayed.

```
----- TOT1(QA +) T27  
399654510 100 m3  
  
<--> RES Tot1
```

5.4.8 "Input/Output settings" menu (if activated)

The input/output modules are:

- As input:
 - Current,
 - Voltage,
 - Temperature (PT100/PT1000),
 - Contact.
- As output:
 - Current/Voltage,
 - Relay.

The menu only appears if inputs or outputs are installed on the flow meter. To install additional inputs/outputs, please contact Ultraflux to find out the specifications of all available inputs/outputs.

1) Current input and voltage input module

```
- INPUT/OUTPUT 2 -
---Input A 4/20mA---
Function =      ON
Value =      Input
              02-A
4mA =      0.350
Range =      4.000
Filter =      0 s
Memory =      0 s

Wiring -----> 02-A
```

```
- INPUT/OUTPUT 3 -
---Input B 0/10V---
Function =      ON
Value =      Input
              03-B
0 V =      0.000
Range =      0.061
Filter =      10 s
Memory =      60 s

Wiring -----> 03-B
```

The possible options are:

- OFF: deactivated,
- ON: activated,
- Simulation.

For ON and Simulation, the following must be defined:

- the value corresponding to 4 mA (for a current input),
- the value corresponding to 0 V (for a voltage input),
- the sensor range,
- the value to be simulated (in simulation mode),
- the value of the filter and the memory (in ON mode).

2) Temperature input module

The possible options are:

- OFF: deactivated,
- PT100-PT1000 mode 2-, 3- or 4-wire (for further details, contact Ultraflux).

Define:

- the type of sensor, Pt 100 or Pt 1000,
 - the type of assembly, 2-wire, 3-wire or 4-wire,
 - the value of the filter and the memory,
 - any offset.
- Simulation
Enter the temperature value to be simulated.

3) Contact input module

The possible options are:

- OFF: deactivated,
- Status: whether the contact is open or closed,
- Pulse: the number of open-close cycles of the contact.

4) Current/voltage output module

```
- INPUT/OUTPUT 4 -  
---Analog output---  
Function = 4-20mA  
Value = Pipe A  
U  
4 mA = 0.000  
Range = 16.000  
I fault = 3.600mA  
Sim. Value = 5.252mA  
-----  
Wiring -----> 04-A
```

The possible options are:

- OFF: deactivated,
- Voltage output:
 - 0-5 V,
 - absolute value |0 - 5 V|.
- Current output:
 - 0-20 mA, 4-20 mA, 0-24 mA,
 - absolute value |0-20 mA|, |4-20 mA|, |0-24 mA|.

For the voltage output and current output choices, the following must be defined:

- the parameter that the output represents. Select the dimension that you wish to associate with the analogue output using the chapter headers (function) and the chapter items (value)
- the base of the scale:
 - value corresponding to 0 mA or 4 mA (for a current output),
 - value corresponding to 0 V (for a voltage output).
- the range,
- the value in the event of a fault in mA (for a current output) or in volts (for a voltage output).

Comment: This module can be used as a current or voltage generator.

5) Relay output module

Each relay output may be configured according to one of the following operating modes:

- *Open*: The relay remains constantly off.
- *Closed*: The relay is on if the Uf 821 is powered on, and off if it is not powered on. This choice therefore allows the relay to be used to detect the presence of the power supply (positive safety).

```
- INPUT/OUTPUT 1 -  
---Relay Output B---  
Function =      CLOSE  
Value      =      Pipe A  
Ø Hertz    =      57.341  
Range      =      0.200  
F fault    =      0 hz  
Sim. Value =      0.0Hz  
  
Wiring -----> 01-B
```

- *Totalizer*: The relay generates a pulse with an adjustable width on each incrementation of the selected totalizer.

```
- INPUT/OUTPUT 1 -  
---Relay Output A---  
Function =      TOT  
Value      =      General  
Step       =      50 ms  
  
Wiring -----> 01-A
```

The pulse width must then be defined, determining the time for which the relay remains closed (the relay, initially off, is then on for half of the period, then off again for at least the same duration).

The value of the relay period must be less than the pulse weight divided by the flow rate.

Example:

Flow rate = 1,000 l/s / Pulse weight = 100 l

We will therefore have 1 pulse every $100/1,000 = 100$ ms

The value of the period must not therefore be greater than 100 ms, at the risk of not counting all of the pulses emitted by the totalizer.

- **Fault:** Depending on the polarity chosen (NO: normally open, NC: normally closed), the relay state changes when the associated fault occurs.

```

- INPUT/OUTPUT 1 -
---Relay Output B---
Function = FAULT
Polarity = NO
Value = General
QT

Rel. Stat= CLOSE

Wiring -----> 01-B

```

In the example, the variable selected is "general Q". This means that the relay closes when the flow meter is not measuring a flow and remains open otherwise.

- **Direction:** Depending on the polarity chosen (NO: normally open, NC: normally closed), the relay state changes when the sign (+ or -) of the associated dimension changes.
- **Threshold:** Depending on the polarity chosen (NO: normally open, NC: normally closed) and the direction in which the threshold is crossed, the relay takes one state if the value is greater than the indicated threshold. The relay switches to the opposite state if the value concerned is lower than the threshold.

Comment: In order to restrict the relay backlash when the dimension concerned fluctuates around the threshold, hysteresis must be defined.

The diagram below illustrates this principle with hysteresis at 2% and the threshold crossed in the ascending direction:

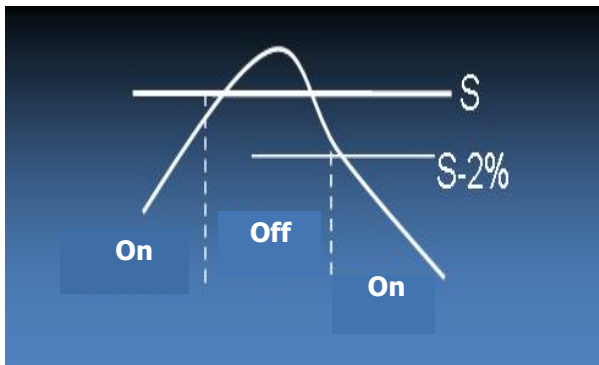

```

- INPUT/OUTPUT 1 -
---Relay Output B---
Function = THRESHOLD
Polarity = NO
Value = Pipe A
Q
Thres.Ua= 57.341
Alarm = Rising
Hystérésis= 2.00%

Rel. Stat= OPEN

Wiring -----> 01-B

```

- **Frequency:** The frequency at which the relay is opened and closed depends on a value to be defined. Example: high flow, high frequency, low flow, low frequency.

```

- INPUT/OUTPUT 1 -
---Relay Output B---
Function = FREQUENCY
Value = Pipe A
Q
0 Hertz = 57.341
Range = 0.200
F fault = 0 hz
Sim. Value = 0.0Hz

Wiring -----> 01-B

```

The following must be defined:

- the parameter that the output represents.
Select the dimension that you wish to associate with the analogue output using the chapter headers (function) and the chapter items (value).
- the value corresponding to 0 Hz.
- the value corresponding to 1 kHz.
- the value in the event of a fault.

The relays can be tested individually: select the open or closed mode on the relay status line.

```
- INPUT/OUTPUT 1 -  
---Relay Output B---  
Function =      CLOSE  
Value      =      Pipe A  
           =      Q  
0 Hertz    =      57.341  
Range      =      0.200  
F fault    =      0 Hz  
Sim. Value =      0.0Hz  
  
Wiring -----> 01-B
```

5.4.9 "Logger settings" menu (if activated)

```
---LOGGER RESET---  
NO  
---Confirmation---  
NO  
-Nbr of Parameters--  
5  
---Logger Mode---  
Cyclic  
---Logger Step---  
1mn  
---Logger Range---  
124d 7h33mn
```

Important: The modification in the number of variables must be preceded by the logger being reset.

1) Resetting the logger

"YES" needs to be entered in the "LOGGER reset" field to reset the logger.

2) Confirming logger reset

The logger is deleted via a field requiring confirmation (protection against handling errors).

3) Number of logger parameters

Up to 30 variables can be recorded in the logger. The number of variables can be adjusted. Its maximum autonomy is for 530,000 time-stamped readings.

4) Logger mode

The logger can record in 2 modes: "rolling" (first files deleted when the logger is full) or "Stop when full" (the logger stops recording when it is full).

5) Logger increments

The recording period of the logger can be set from 1 s to 24 hrs: 1 s, 5 s, 10 s, 30 s, 1 min, 2 mins, 5 mins, 10 mins, 15 mins, 30 mins, 1 hr, 2 hrs, 6 hrs, 12 hrs and 24 hrs.

6) Logger autonomy

This field cannot be edited and indicates the logger's remaining autonomy.

7) Logger variables

For each of the variables of the logger, one of the following functions can be selected:

General Status	VALUE 1	
Pipe A Q	VALUE 2	AV.
Pipe A H.water	VALUE 3	AV.
Pipe A U	VALUE 4	AV.

- *AVG*: average value over the recording period,
- *MIN*: minimum value over the recording period,
- *MAX*: maximum value over the recording period.

8) Logger on variation

The variation mode of the logger is used to reduce the recording period for the data in the logger.

To do this, define the maximum variation percentage with regard to the previous recording. If the variation measured is greater than this maximum, the recording is instantly triggered (no more than once per second).

records	Variation
= YES	
Pipe A Q	1.0%
Pipe A Q	0.1%
Pipe A Q	0.0%

Comment: A percentage equal to 0% disables the associated value.

The following figure shows the reduction in the period of the logger when the flow experiences a variation:

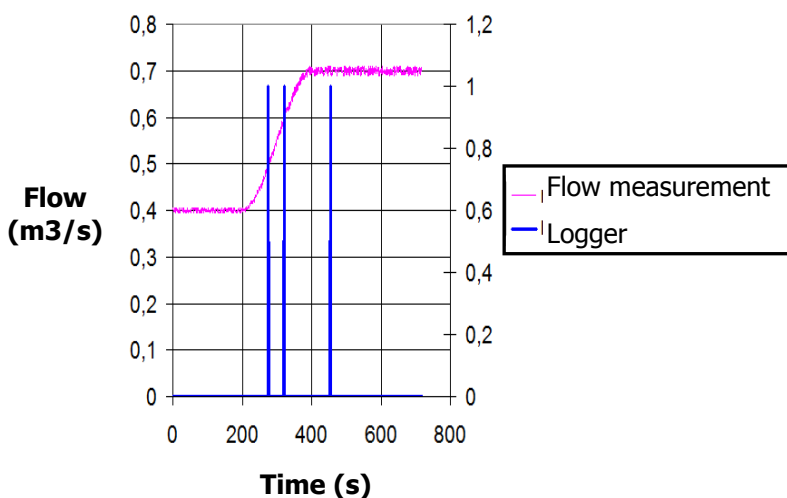

The vertical lines (blue) correspond to the triggering of records of the logger. If the variation of the flow is greater than the configured threshold, the logger forces a recording.

5.4.10 "Echo Display" menu

Please note: The "Echo Display" mode blocks the measurement function. The measurement values are no longer calculated, the logger no longer records data.

This mode is used to view the acoustic signal of each chord, which is of use during the commissioning or maintenance phase, or for example:

- to check the connection of the probes and their good working order,
- to check that the probes are placed at the correct distance,
- to find the origin of a measurement incident (clogging of the probes, obstruction of the structure between the probes, unforeseen pollution, rupture of a probe cable, etc.).

Comment: Various characteristic signals are analysed in Appendix 1.

"Echo Analysis" mode includes two screens per chord:

- The first displays the acoustic signal between the emission (for short travel times) and the echo analysis zone. This screen is called the "landscape" display:

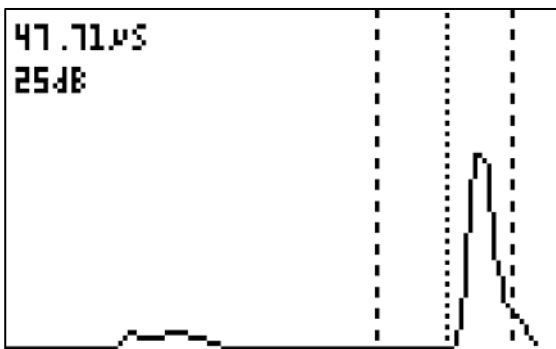

- The two dashed vertical lines give the zone in which the echo is expected. An echo received outside of this zone is not taken into account.
- The dotted vertical line gives the measuring point on the echo.
- The number of the chord is indicated below the graph.
- In the top left hand corner of the screen, the gain applied to the echo and the sound path duration are shown.

Comment: If no acoustic signal reaches the expected zone (for example if one of the probes is not connected, or if one of the probe cables is damaged), the screen displays a "!" sign in place of the acoustic signal.

- The second screen shows a zoom on the echo chosen for the measurement. This screen is called the "zoom display":

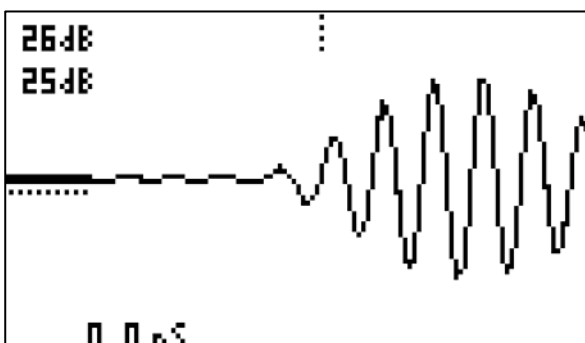

- The horizontal bar continues to indicate the noise level.
- The dotted vertical bar marks the place where the travel time is measured. Absence of this bar means that no measurement is taken (for example if there is too much disturbance).
- The dashed horizontal bar indicates the measurement threshold. The measurement is taken the first time the alternation that crosses this threshold reaches 0.
- The ultrasound path duration delta is indicated in the bottom left hand corner (not taking into account the ΔT_0).

5.5 NORMAL configuration mode

Comment: This section will be restricted to an explanation of the additional functions of "normal configuration" compared to "simple configuration". The entire common base already explained in the "simple configuration" section is not repeated in this section.

5.5.1 "Pipe/fluid settings" menu

1) Memory

The memory is the time, given in seconds, for which the measurement is stored in memory when a measurement is lost (echo loss).

This storage is used in particular to avoid inopportune actions from the instrumentation and control part of the installation.

Two situations may arise:

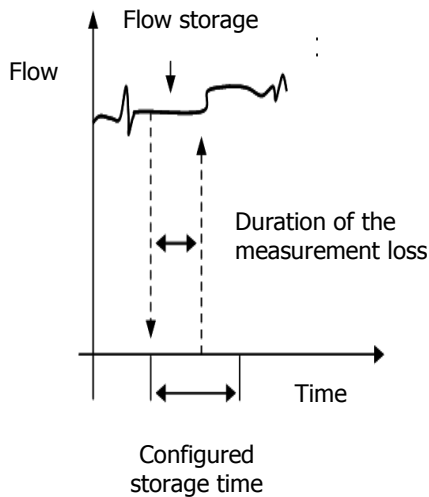

Situation 1: Measurement loss duration less than the storage time. In this case, the flow meter keeps the last measurement until a new measurement is valid.

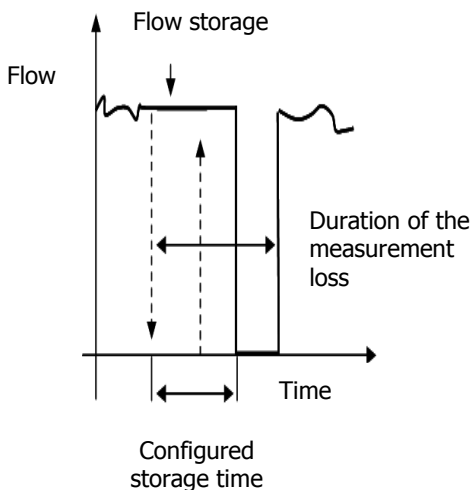

Situation 2: Measurement loss duration greater than the storage time. The flow meter extends the last measurement until the time that has passed is longer than the storage time. The flow measurement is then given as faulty if there is still no new valid flow measurement.

2) Filter

The flow measurement can be filtered so as to make the measurement results more legible.

```
----- CHANNEL A-----  
Memory      =      60s  
Filter      =      180s  
DeltaU Fil.=5.000m/s  
-----Calibration-----  
CutOff Qc = 0.01m3/s  
-----Fluid-----  
Product     =  
            water (20 C)  
C0          = 1482m/s  
DeltaC     = 388m/s
```

This feature must be used when the flow is extremely chaotic and an average for the flow needs to be produced in order to view its evolution.

The diagram below illustrates the effect of the filtering in the event of a very versatile and turbulent measurement:

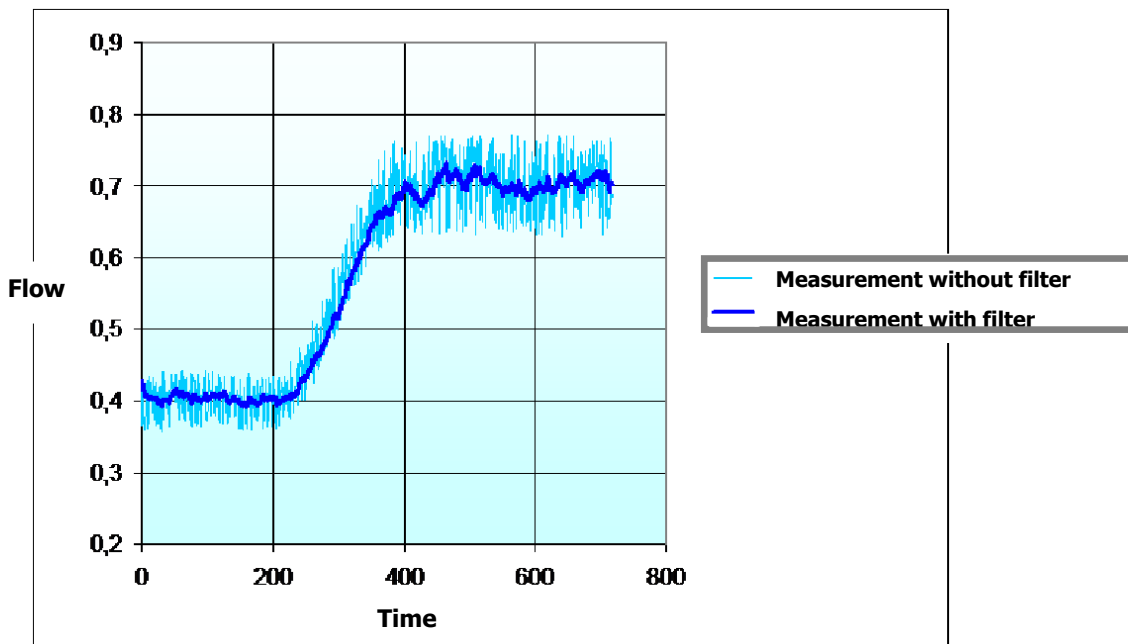

The filter time constant, given in seconds, defines the "force" of the filtering: following a flow rate step (quick opening of the isolation dam), the value measured reaches the final value at 1% after the time constant.

To adjust this time constant, a simple rule involves taking as the time constant a value equal to two or three times the foreseeable duration of any interference: for example, if you wish to avoid seeing flow variations quicker than every 20 seconds, give the time constant a value of 40 or 60 s.

However, you must ensure that the time constant is not too large, since this would risk masking significant events.

3) Deletion rate (CutOff Q)

The deletion rate is the flow rate value below which the flow meter displays 0. This gives us a clear indication of a flow rate considered to be zero.

4) Product

Drop-down list for choosing the type of product transported in the channel.

5) Delta T0

The deltaT0 field is used to correct installation errors. For example, it is possible to compensate for a bias due to an incorrect position of the probes by adding to deltaT0 the value required in order to rectify it.

6) Vmin and Vmax

In certain situations, the velocity of the fluid measured by the flow meter may be disrupted. Limits can then be set for the velocity of the fluid using a minimum velocity and a maximum velocity.

7) Probe immersion depth

```
----- CHANNEL A -----  
----- Chord 1 -----  
Probe      = SI1611/05  
Length    = 1.34870m  
Axial D.  = 1.12100m  
CoefChord = 1.000  
Height    = 0.324m  
DeltaT0   = 0.00ns  
Seek Gain = 300dB  
Gain Max  = 96dB  
U. Min    = -5.00m/s  
U. Max    = 5.00m/s  
immersion = 100mm
```

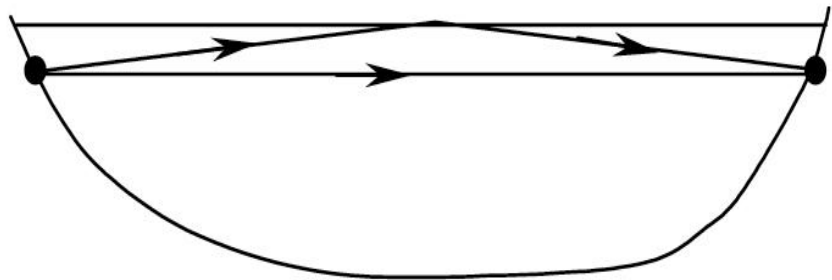

For it to be possible for the velocity measured by a chord to be included in the flow calculation, the chord must be sufficiently submerged so as not to suffer disturbances created by the trough of the wavelets or for there to be no interference between the direct path of the ultrasonic wave and the path of the wave reflected by the surface.

If the signal generated by the reflected wave follows the signal generated by the direct wave too closely, the wanted signal may be appreciably altered by the secondary signal. The minimum immersion depth of the probes below which the measured velocity is considered invalid must therefore be indicated. This minimum immersion depends on the frequency used and the length of the acoustic path.

Comment: The immersion depth of the probes is counted from the central plane of a chord.

5.6 ADVANCED configuration

Comment: This section will be restricted to an explanation of the additional functions of advanced configuration compared to the two modes defined above (simple and normal). The entire common base already explained above in this document is not repeated in this section.

5.6.1 "Pipe/fluid settings" menu

1) Delta V filtering

When a filter has been activated, it is possible to request that the flow meter disables the filter if the measurement evolves very quickly. This provides a filter which is sufficient to comfortably see the evolution of the measurement and to retain reactivity while not filtering large variations in velocity.

```
----- CHANNEL A-----
Memory      = 60s
Filter      = 180s
DeltaU Fil.= 5.000m/s
-----Calibration-----
CutOff Q. = 0.01m³/s
-----Fluid-----
Product    =
           water (20 C)
CØ         = 1482m/s
DeltaC     = 388m/s
```

2) Weighting coefficients of the chords

A weighting coefficient is a corrective factor and is applied when calculating the velocity. For example, if you wish to reduce the velocity of a chord by 10%, a coefficient of 0.9 must be entered.

```
----- CHANNEL A-----
-----Chord 1-----
Probe      = SI1611/05
Length    = 1.34870m
Axial D.  = 1.12100m
CoefChord = 1.000
Height    = 0.324m
DeltaT0   = 0.00ns
Seek Gain = 30dB
Gain Max  = 96dB
U. Min    = -5.00m/s
U. Max    = 5.00m/s
immersion = 100mm
```

3) Required gain and Maximum gain

The gain is the parameter which determines the amplification of the ultrasonic signal required for the flow meter to take a measurement. If the flow meter needs to increase the gain, this means that the ultrasonic signal received is very weak. The poorer the quality of the signal, the greater the gain and the more difficult it is to measure the flow.

Using the maximum gain parameter, you can limit the gain so that the unwanted acoustic noise does not disrupt the operation of the flow meter.

Important: It is highly recommended to contact Ultraflux before modifying these settings.

5.6.2 "Linearization settings" menu

One last action possible on the flow is the linearization of the result. Depending on the flow, the flow is corrected by X% based on a pre-defined table:

----- -QA -----			----- +QA -----		
Q ref=		θ (m ³ /h)	Q ref=		θ (m ³ /h)
Coef. 0	% =	1.0000	Coef. 0	% =	1.0000
Coef. 10	% =	1.0000	Coef. 10	% =	1.0000
Coef. 20	% =	1.0000	Coef. 20	% =	1.0000
Coef. 30	% =	1.0000	Coef. 30	% =	1.0000
Coef. 40	% =	1.0000	Coef. 40	% =	1.0000
Coef. 50	% =	1.0000	Coef. 50	% =	1.0000
Coef. 60	% =	1.0000	Coef. 60	% =	1.0000
Coef. 70	% =	1.0000	Coef. 70	% =	1.0000
Coef. 80	% =	1.0000	Coef. 80	% =	1.0000
Coef. 90	% =	1.0000	Coef. 90	% =	1.0000
Coef. 100	% =	1.0000	Coef. 100	% =	1.0000

The parameter Q ref defines the maximum flow used for the linearization. The points of the table are then defined as a percentage of this maximum.

The rectifier coefficient must be defined by the user:

- A coefficient of 1 does not change anything in the result.
- A coefficient of 0.8 reduces the value of the flow by 20% at this point, etc.

There are two tables, one for positive flows and one for negative flows.

5.6.3 "Advanced configuration" menu

1) Simulation mode

----- CHANNEL A-----	
Function =	Measure

The flow meter can be used:

- in Measurement mode (normal operation of the flow meter),
- in Velocity simulation mode.

Enter the value of the flow velocity required and the sine wave (as a percentage) applied around this value.

Comment: A modulation of 0% keeps the flow velocity constant. A modulation of 100% fluctuates the simulated velocity between 0 and 2 times the indicated value.

To simulate the level, go to the input/output settings and change the simulation value in the input corresponding to the level measurement (see chapter dedicated to inputs/outputs).

2) Special probes

It may be necessary in certain cases to define a probe which is not referenced in the list of Ultraflux probes. Before using this option, it is highly recommended to contact Ultraflux.

To use probes other than Ultraflux probes, use the "special probes" function.

```
-- SPECIAL PROBES --
-----Probe SA-----
T0   = 0.00µs
F    = 2Mhz
Angle= 0.00
Text =SA
-----Probe SB-----
T0   = 0.00µs
F    = 2Mhz
Angle= 0.00
Text =SB
```

T0 represents the dead time of the probe.

F represents the frequency of the probe.

Angle corresponds to the angle of the ultrasonic probe. For an open channel probe, the angle is always 0.

Text is used to identify the special probe in the list of references of accessible probes.

3) US & TRT processing

These settings allow the Ultraflux teams to adapt the operation of the flow meter to a specific case. You must consult us before modifying these settings.

5.6.4 "Firmware update" menu

This option is used to update the flow meter without needing to uninstall it. Consult us prior to using this option.

5.7 "Measurement" mode

The flow meter has measurement pages (different values are displayed, page after page) and a flow graph.

5.7.1 Available pages

The Measurement screens give a large amount of information: the pages scroll down and are accessible using the ▲ and ▼ keys.

The same information is displayed for each of the chords of the application:

1) Flow rate

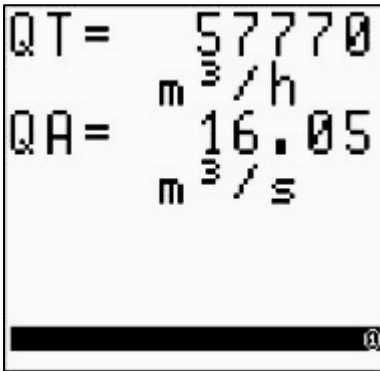

This page displays the flow measured with the unit.

2) Channel measurement



This page displays the data relating to the flow: rate, average velocity in the channel, water level.

3) Specific information relating to the chords

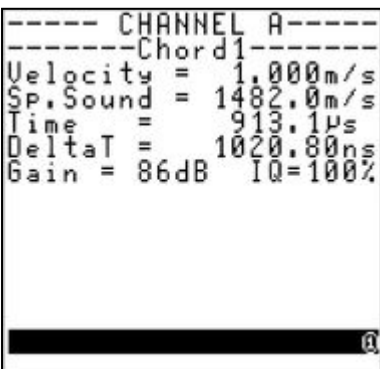

These pages (depending on the number of chords) provide information on the specific measurements for a chord:

- average time (average of the time for the upstream-downstream journey and the time for the downstream-upstream journey),
- delta T (time difference between the upstream-downstream journey time and the downstream-upstream journey time),
- measurement gain (the higher the gain, the more difficult it is to obtain a measurement),
- QI quality index (100% indicates a very good measurement, 0% indicates that the measurement is not possible).

4) Totalizers

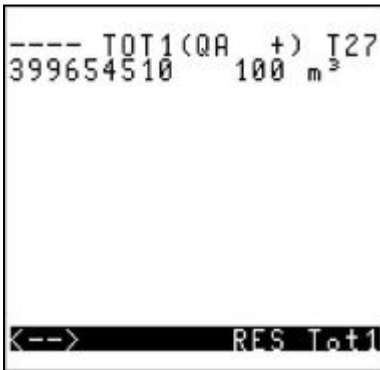

This screen indicates the metering status of the totalizers and allows them to be reset (if authorised).

5) Date and time



This screen indicates the date and time of the flow meter and the information concerning the last powering on.

“Pipe all all”: information for Ultraflux use only.

6) Logger info



This page indicates the status of the logger and the last recording made.

7) Events

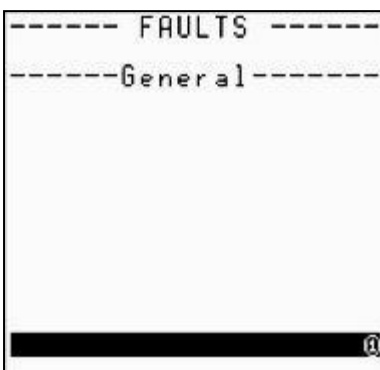

These pages are used to find out whether there is a problem on the flow meter and to localise it in order to resolve it.

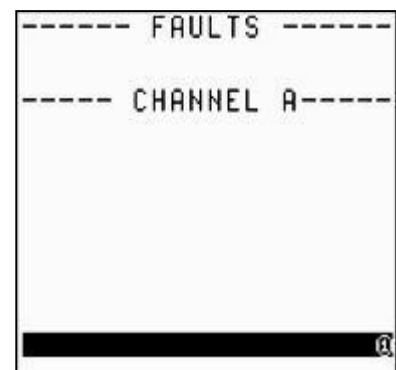

8) Probe type



These pages (depending on the number of chords) provide the reference of the associated probes for each chord.

9) Flow graph

The flow graph is a screen for displaying changes in a particular magnitude on a curve.

5.7.2 Verification of measurement quality and consistency

The information on the different "Measurement" mode pages is used to check the consistency of your measurement.

The gain and QI (quality index) values also tell you about the quality of your measurement.

CHAPTER 6: FUNCTION ENGINE

6.1 Principle

Each Uf 821 includes a miniature PLC. This PLC allows Ultraflux to easily install additional features for this flow meter.

On request, Ultraflux can quickly integrate a new feature for your Uf 821.

6.2 Application example

6.2.1 Water temperature calculation

The water temperature can be determined from its celerity (via a calculation).

You will find in the appendix the polynomial used to determine the temperature of the water based on the celerity measured by our flow meters.

The function engine allows us to carry out this calculation internally in the flow meter

CHAPTER 7: PC SOFTWARE

7.1 Introduction

The PC software is used to configure the flow meter using a PC, rather than accessing the parameters using the flow meter's keypad.

It is used in particular:

- to define all settings for the application,
- to monitor, in real time, the measurement parameters (flow, average velocity, speed of sound and gain for each chord, etc.),
- to save the measurement or settings data in a file for later consultation,
- to download, using the serial link or USB, the flow meter operation settings, the measurement data, the logger,
- to print the displayed data,
- to transfer the measurement and logger data to a spreadsheet program.

The minimum requirements are a PC with Windows version XP or later.

7.1.1 Installing and running the software

To install the software:

1. Run the Setup.exe installation program on the CD-ROM,
2. Select the language to use for the installation and for displaying the screens,
3. Using the Browse button, specify the software installation path (by default C: \ Program Files \ Ultraflux \ [PC software corresponding to your flow meter].x, with x designating the version no.).

Comment: For an identical reinstallation of the program (for example in the event of damage to the execution file) or to uninstall it, select the program from the list of installed programs (Start / Settings / Control panel / Add/Remove programs) and click the Add/Remove button.

A window asks you which action you wish to carry out: Change (function not available for the software, since it only contains a single component), Repair or Remove.

The program is run by double-clicking the icon associated with the  software and placed on the desktop, or by selecting the program via Start \ Programs \ Ultraflux \ software corresponding to your flow meter.

The choices proposed by the three main menus are:

- "File" menu – to:
 - Open a measurement file, settings or logger (via the "*Open*" command),
 - Create a settings file (via the "*New*" command),
 - Close the program (via the "*Exit*" command).

- "Dialogue" menu – to:
 - Open the measurement window,
 - Open the settings window,
 - Modify the access code,
 - Download the logger data from the flow meter to the PC,
 - Display the echo,
 - Save all flow meter settings.

- "Options" menu – to:
 - Configure the PC software,
 - Load the configuration file,
 - Save the configuration file.

- "About" menu – to:
 - Get information about the PC software version.

7.1.2 Connecting the flow meter to the PC

To connect the Uf 821 to the PC, you must connect the lead provided (serial link or USB cable). The exchanges are made in the JBus/ModBus protocol, the PC being master and the Uf 821, identified by its number, being the slave.

7.1.3 Home page



When run, the software displays the following window:

This window contains four main menus:

- "File",
- "Dialogue",
- "Options",
- "About".

First open the Options menu to define the settings relating to your application.

7.1.4 Options window

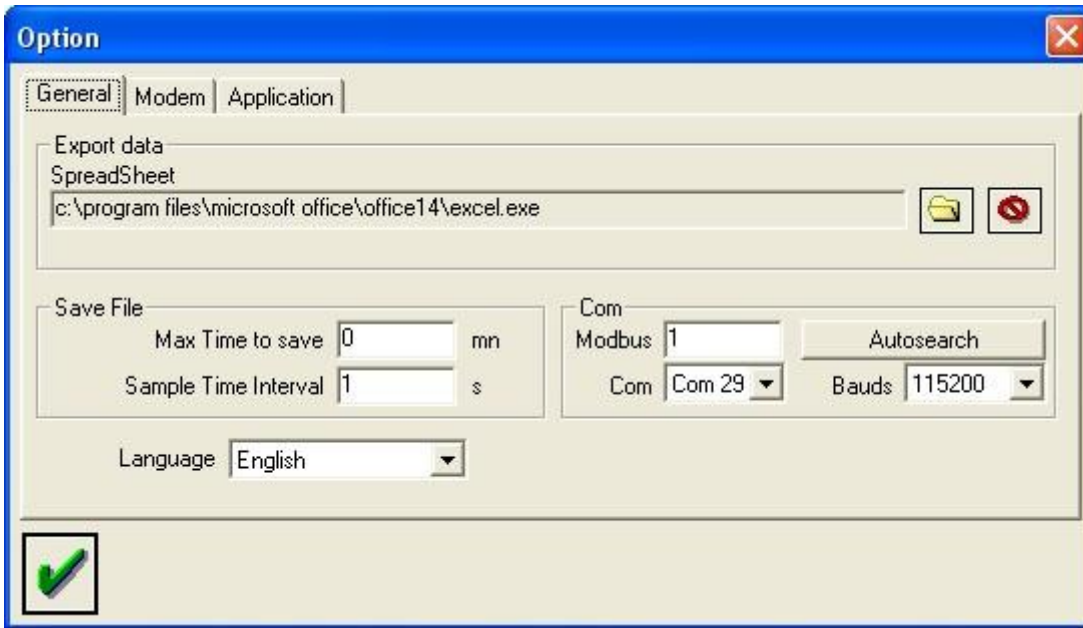

The window opened by the Options menu is used in particular to select the display language and to define the path of the software used to work with the data (Excel by default, if this is installed on your computer).

It also includes a "**Autosearch**" button used to automatically detect the presence of an Ultraflux flow meter.

Comment: To use the serial link, the transmission speed can be set from 300 to 115,200 bauds, the fastest speed being preferable, especially for data-logger downloads.

7.1.5 Icons

Icons are displayed at the bottom of each window under the "Dialogue" menu.



This disk icon runs the save procedure. The software then asks you for the name of the folder in which to save. You can then read, print or handle these records in Excel (or other data processing software) using the command File / Open / [save name].

Comment: When measuring, once the saving has started ("Save" button), the data is saved at the pace established by the period entered in the Options menu of the software, for the time established. When Time = 0, it is stopped manually.



This icon is used to print all data displayed on the screen.



This icon launches the data transfer procedure from the PC to the flow meter.

7.1.6 File menu

The File menu allows you to open a saved file ("Open" command), or prepare a settings file offline ("New" command). Once the file has been saved, you can export it to a Uf 821.



7.1.7 Measurement window

The measurement window is opened using the Dialogue/Measurement command.



1) List of available tabs

The measurement window has the following tabs:

- "General" tab: contains general information about the measurement.
- "QA" (flow rate) tab: contains general information about the measurement channel.
- "Inputs/outputs" tab: contains general information about the inputs-outputs.
- "Function" tab (optional): contains settings information for the function engine if this is used (tab only appears if at least 1 engine output is configured).

2) "General" tab

This tab displays the main measurement information: graph of the measurement, point value for the flow and the flow velocity, totalizers.

The screenshot shows the 'Measurement' window with the following data:

- Navigation:** General | QA | Function | Input-output 01-04
- Timestamp:** 02/05/2012 - 17:01:23
- Defaults:** (Empty field)
- Totalizer(s):** Tot. 1 : QA (+) 399737962 x 100 m3
- Flow Rate (QA):** 19.49 m3/h
- Flow Velocity:** 0.021 m/s
- Graph Area:** 10.0 m3/h (top), 0.0 m3/h (bottom)
- Unit Information:**
 - Version: (Empty)
 - Unit Name: UF8xx
 - Type: 2 Pipes
 - Firmware: 26-15-05-A(862*) | 00-72-05-K.d(860*)
 - Serial Nbr.: 40/11/0069 | Hardware: MK6-G

3) "QA" tab (flow rate)

This tab displays the main information about the measurement channel: value of flow, flow velocity, section and height of water. It also provides information concerning the measurement chords.

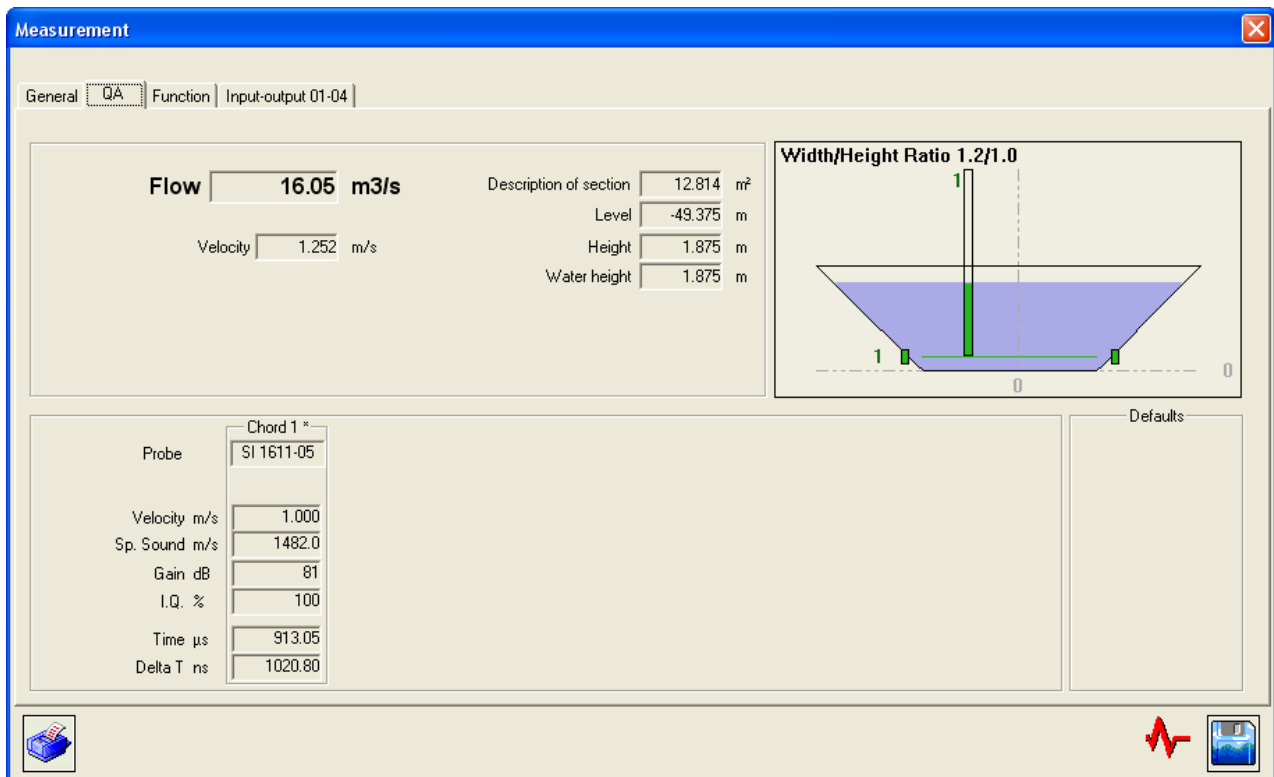

Comment: There are as many tabs as there are channels configured.

4) "Input-output" tab

This tab displays the information concerning the inputs/outputs of the flow meter.

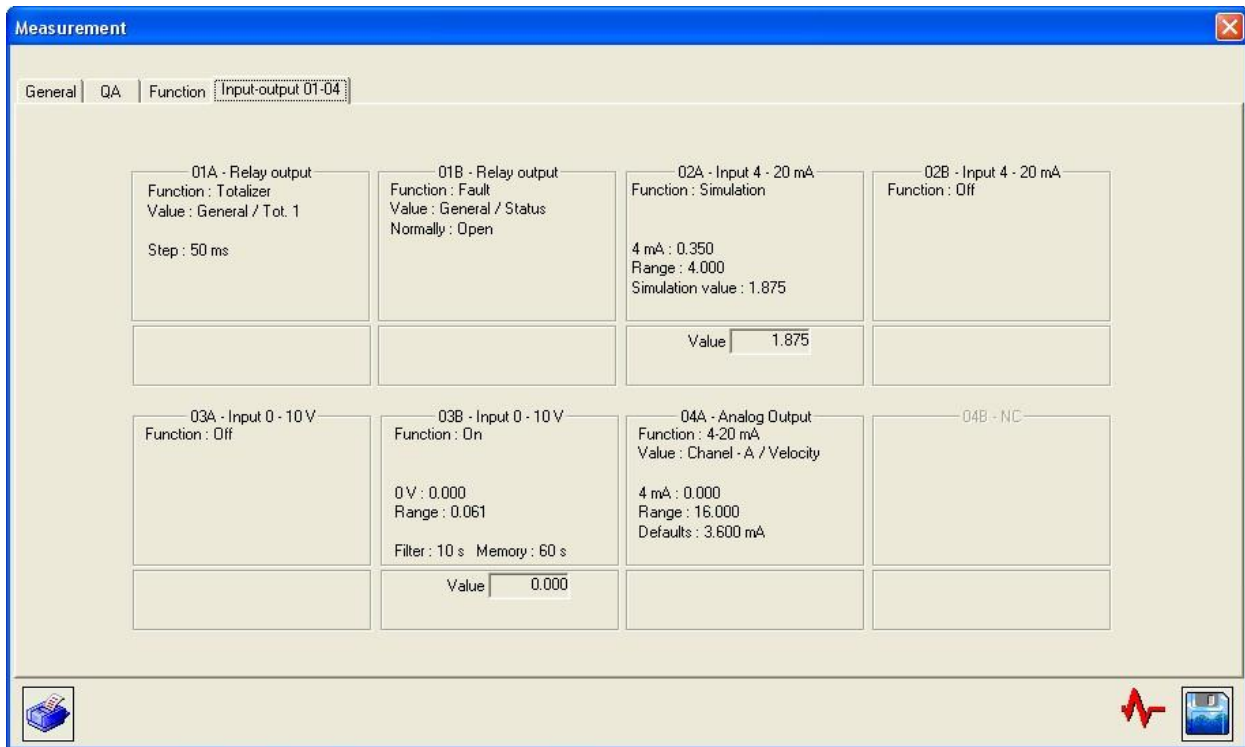

7.1.8 Settings window

1) List of available tabs

This window, opened using the Dialogue/Settings command, contains the following tabs:

- In the "General" drop-down menu
 - "General" tab: selection of the flow meter display language (and name of the flow meter defined during the installation).
 - "Logger" tab: description of the operation of the logger.
 - "Totalizer" tab: definition of the operation of the totalizers.
 - "Function" tab: definition of the engine input constants accessible to the user (when a function is located in the engine).
 - "Advanced" tab: definition of the Advanced operating mode.
 - "Inputs/outputs" tab: definition of the input/output settings (including the 4-20 mA inputs for the Level inputs).

- In the "Channel" drop-down menu
 - "Channel" tab: time constants, flow graph settings, display options, etc.
 - "Chord" tab: definition of the probes, positions of the chords, etc.
 - "Advanced chord" tab: definition of specific codes used to fine-tune the behaviour of the flow meter (contact Ultraflux before modifying these settings).
 - "Section" tab: definition of the geometry of the measurement section.
 - "Hydraulic profile" tab: settings of the measurement section hydraulic profile.
 - "Level" tab: number of level measurements and assignment of the inputs.
 - "Height/velocity" tab: definition of the operation of the flow meter in low water mode.
 - "Linearisation" tab: flow rate linearisation coefficient.



Once configuration is complete, upload the configuration to the flow meter by clicking this button.

Comment: On opening the settings window, the configuration loaded in the PC is the current configuration of the flow meter.

2) "General" tab (in the "General" drop-down menu)

The settings window is used to configure the flow meter from the PC. As with the keypad, you can choose the level of complexity using the command: General/Application Selection/Level = Simple, Normal or Advanced.

The screenshot below shows an example of settings in Advanced mode. All parameters displayed below are described previously in this document (see Chapter 5).

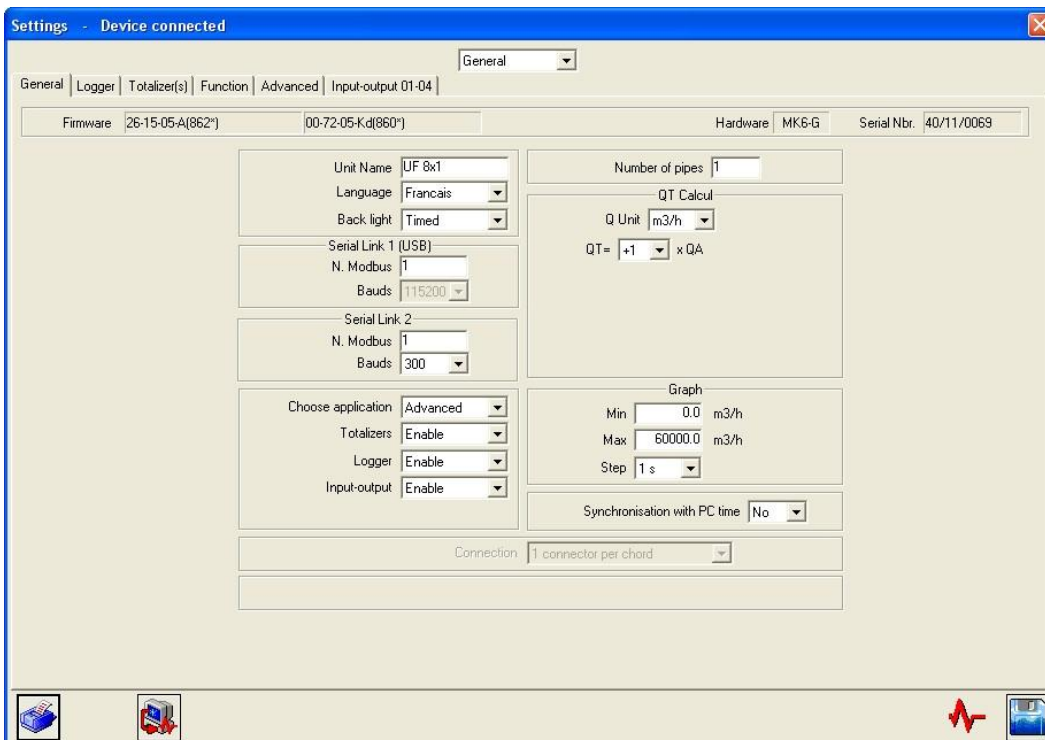

The software allows the date and time of the Uf 821 to be synchronised with the date and time of the host PC: select the option "Synchronise with PC time" before saving the settings on the flow meter.

It is important to correctly set the date and time in order to time stamp the records (country, summer/winter time).

3) "Logger" tab (in the "General" drop-down menu)

The screenshot below shows an example of settings in Advanced mode. All of the parameters displayed below are described previously in this document (see part 5.4.9).

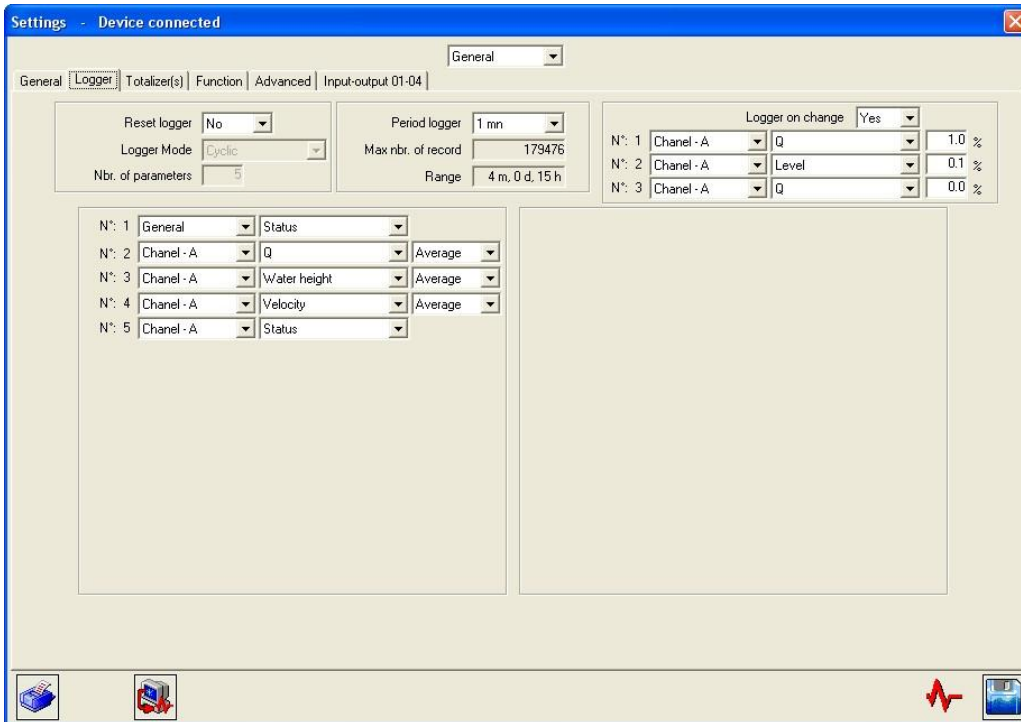

4) "Totalizers" tab (in the "General" drop-down menu)

The screenshot below shows an example of settings in Advanced mode. All of the parameters displayed below are described previously in this document (see part 5.4.7).

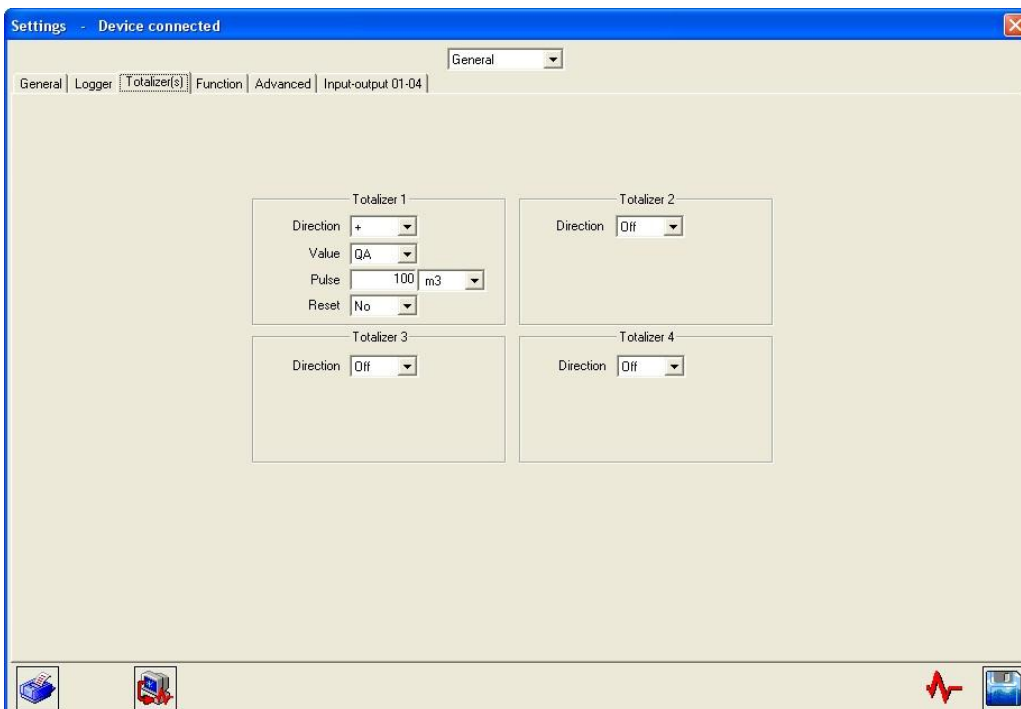

5) "Inputs/Outputs" tab (in the "General" drop-down menu)

The screenshot below shows an example of settings in Advanced mode. All of the parameters displayed below are described previously in this document (see part 5.4.8).

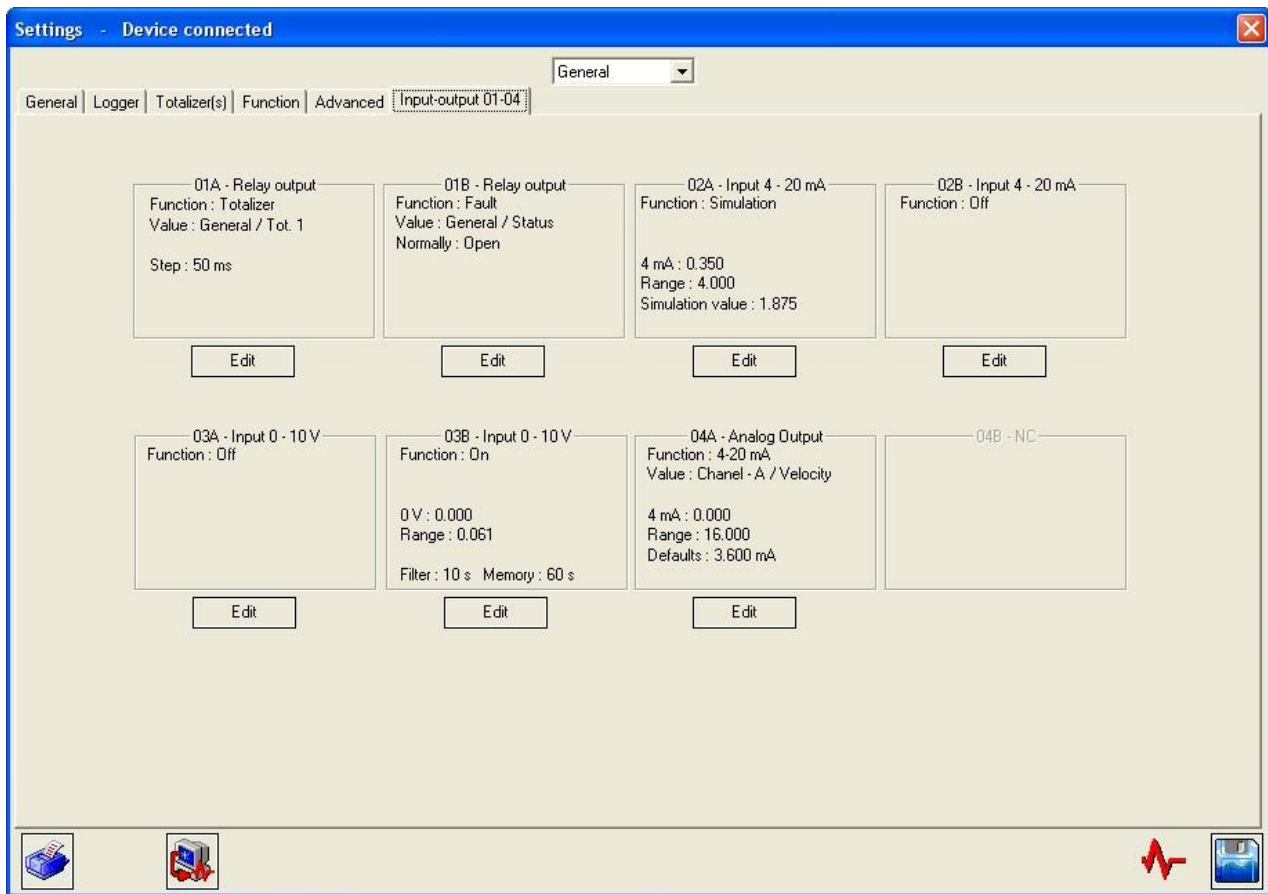

You can choose whether or not to activate the Totalizer, Logger and Input/Output functions resources.

6) "Channel" tab (in the "Channel" drop-down menu)

The screenshot below shows an example of settings in Advanced mode. All of the parameters displayed below are described previously in this document (see part 5.4.2).

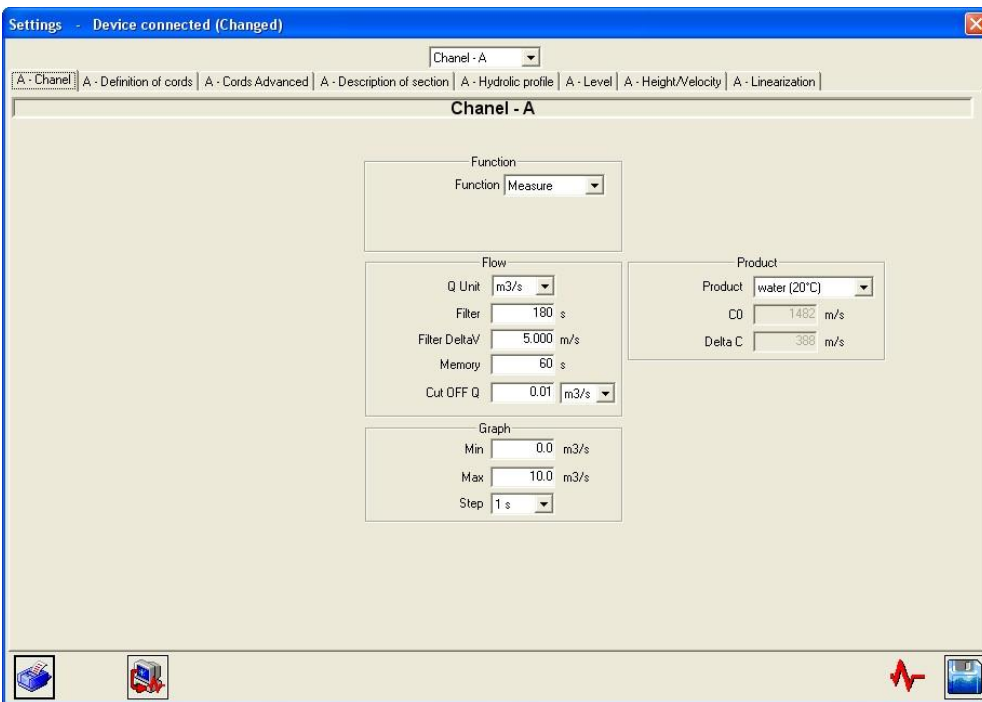

7) "Chord" tab (in the "Channel" drop-down menu)

The screenshot below shows an example of settings in Advanced mode. All of the parameters displayed below are described previously in this document (see part 5.4.2).

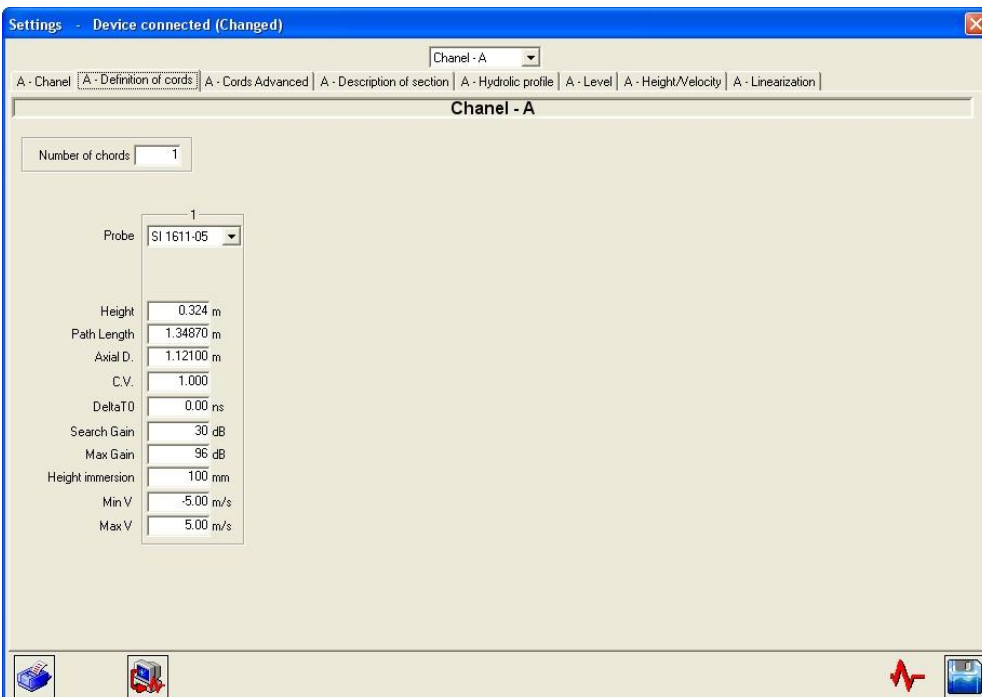

Note: It is possible to enter in the flow rate calculation a chord external to the converter (for example, a Doppler velocity measurement).
The settings to be defined for this chord are the same as those for the internal chords, but the following must also be defined:

- the internal chord associated with the external chord: when the internal chord is faulty, it is the external chord which takes over.
- the input module which will serve as a velocity measurement: a 4-20 mA module may serve to recover a Doppler velocity.

The main advantage of this virtual chord lies in being able to measure the flow using several measurement methods.

8) "Section" tab (in the "Channel" drop-down menu)

The screenshot below shows an example of settings in Advanced mode. All of the parameters displayed below are described previously in this document (see part 5.4.3).

	Height	Left width	Right width
20	2.289 m	-5.240 m	4.680 m
19	2.169 m	-5.093 m	4.539 m
18	2.048 m	-4.946 m	4.399 m
17	1.928 m	-4.799 m	4.258 m
16	1.807 m	-4.653 m	4.118 m
15	1.687 m	-4.506 m	3.977 m
14	1.566 m	-4.359 m	3.837 m
13	1.446 m	-4.212 m	3.696 m
12	1.325 m	-4.065 m	3.556 m
11	1.205 m	-3.918 m	3.415 m
10	1.084 m	-3.772 m	3.275 m
9	0.964 m	-3.625 m	3.134 m
8	0.843 m	-3.478 m	2.994 m
7	0.723 m	-3.331 m	2.853 m
6	0.602 m	-3.184 m	2.713 m
5	0.482 m	-3.037 m	2.572 m
4	0.361 m	-2.891 m	2.432 m
3	0.241 m	-2.744 m	2.291 m
2	0.120 m	-2.597 m	2.151 m
1	0.000 m	-2.450 m	2.010 m

These three buttons are used to define the sections of predefined shapes (rectangle/trapezium/circle) via a "wizard".

9) "Hydraulic Profile" tab (in the "Channel" drop-down menu)

The screenshot below shows an example of Advanced settings. All of the parameters displayed below are described previously in this document (see part 5.4.5).

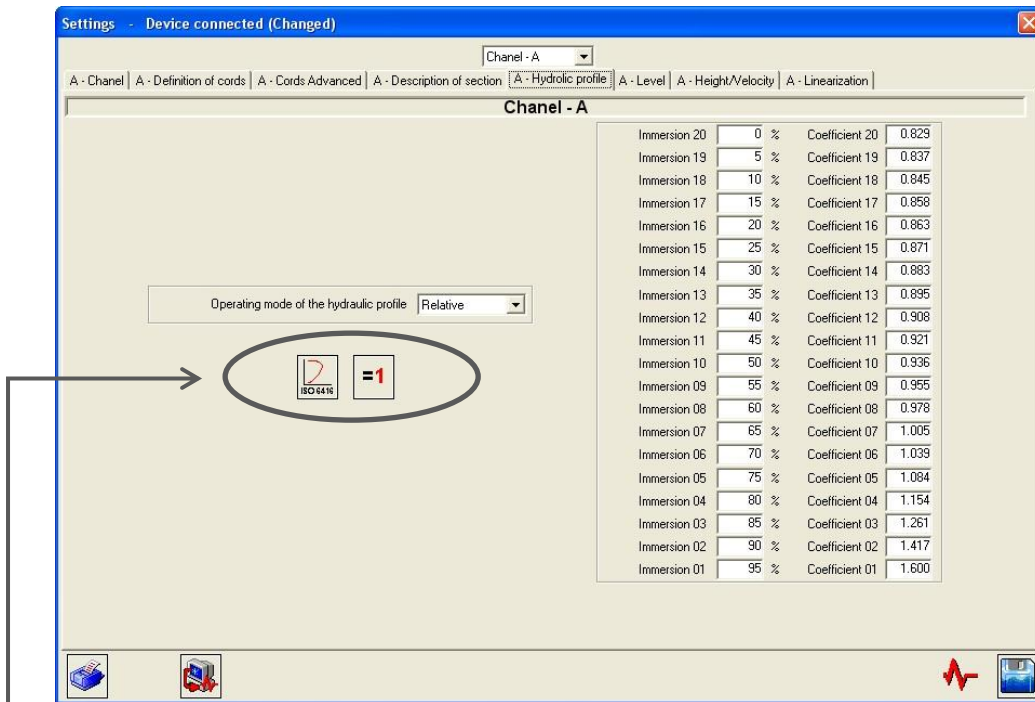

→ These buttons are used to force the hydraulic profiles (with standard ISO 6416 or with all coefficients equal to 1).

10) "Level" tab (in the "Channel" drop-down menu)

The screenshot below shows an example of Advanced settings. All of the parameters displayed below are described previously in this document (see part 5.4.4).

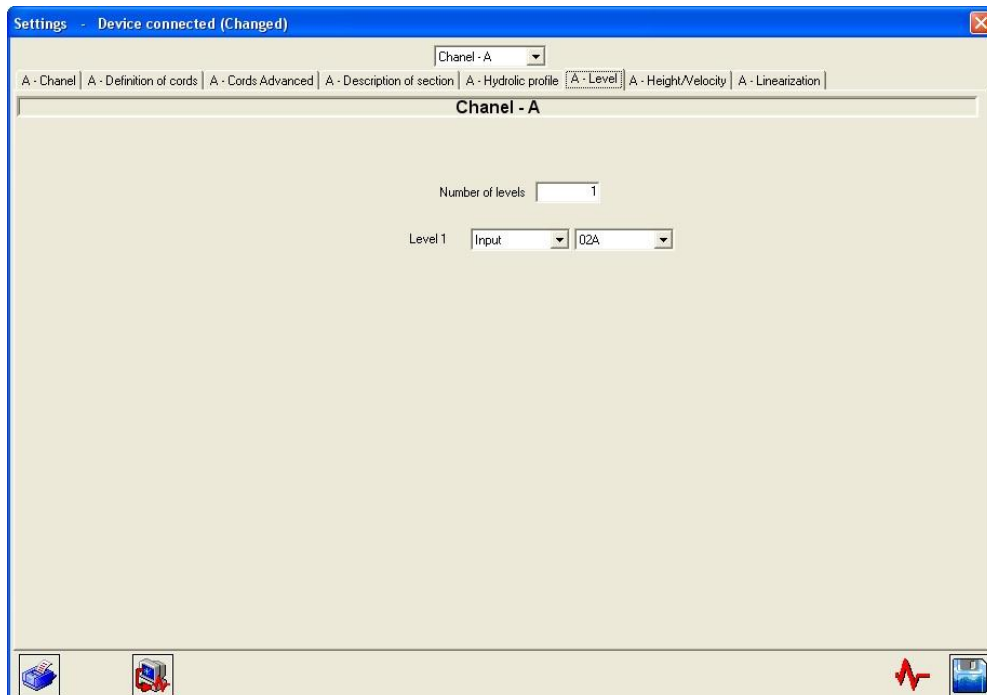

11) "Height/Velocity" tab (in the "Channel" drop-down menu)

The screenshot below shows an example of Advanced settings. All of the parameters displayed below are described previously in this document (see part 5.4.6).

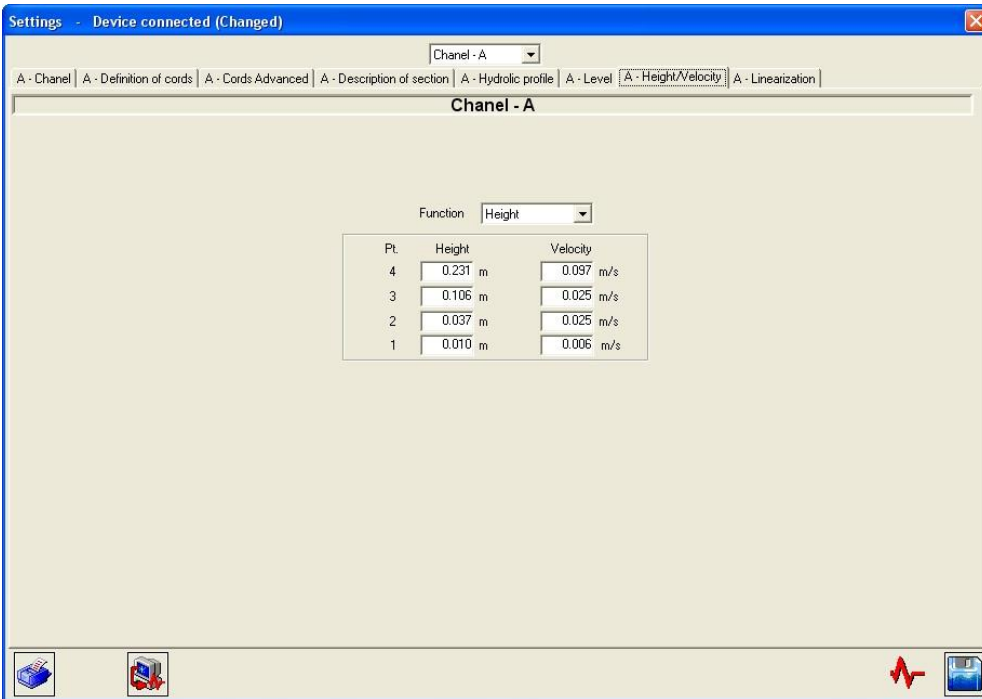

12) "Linearisation" tab (in the "Channel" drop-down menu)

The screenshot below shows an example of Advanced settings. All of the parameters displayed below are described previously in this document (see part 5.6.2).

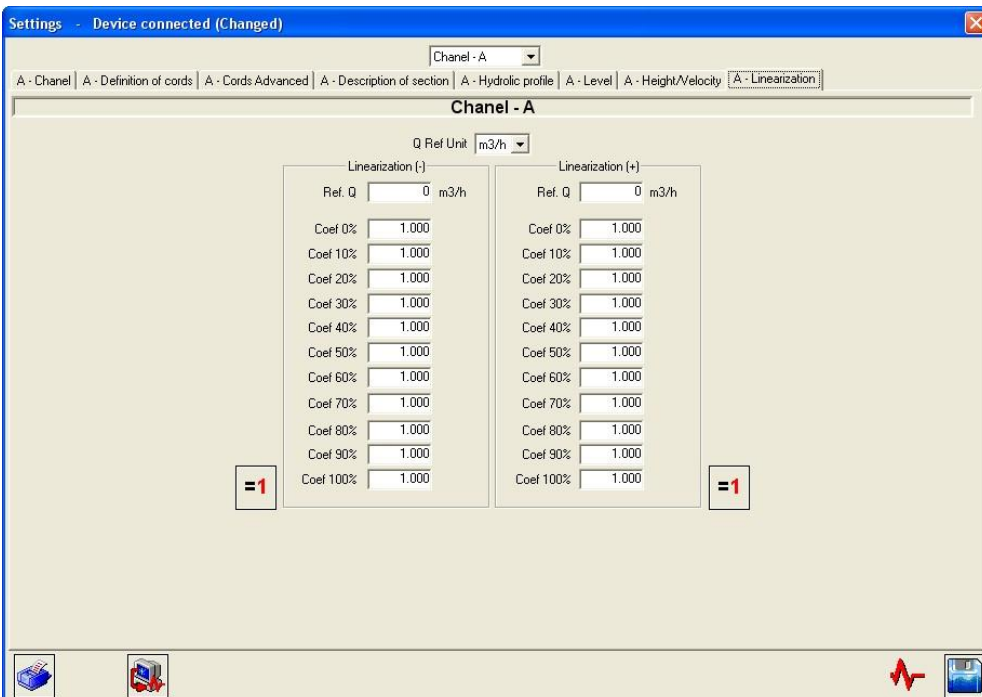

7.2 Archiving, processing and printing of saved files

You can save the settings for the flow meter and the associated measurement results.

These are complete records of the measurements and conditions observed, which are a useful addition to those of the data logger. The files are named with an extension [*.mes].

These records on the screen are presented in the same way as the Measurement dialog (see section 5.8), with a few additional icons at the bottom of the screen.

Use the following buttons to browse or select the records:



Use the following button to print the records:



If you have saved a sequence (Configuration/General/Save file/Period and Time) command), you will be able to process this data with the software used for data handling (Excel by default, if this is installed on your computer). A macro for Excel is provided.

Data processing is called by clicking the following button:



In the windows opened, confirm the name of the file to be processed, and accept the macro. You should first specify the security level of this macro.

The results from the measurement pages are automatically arranged in the columns and rows of Excel, and the flow and velocity curves are produced. You can then freely modify this data.

7.3 Settings files

The Uf 821 has 11 spaces in its free memory for the storage of configurations (see part 5.4.1): you can therefore recall or save your selections.

Important: only the first 5 locations are accessible from the PC software, the other 6 may only be accessed via the converter.

Appendix I: Characteristic echo signals

The most common echo signals

The display of the echo signal is not essential, but does facilitate the implementation of the measuring point. It also allows the origin of a problem to be detected.

The positioning and orientation of the probes are correct when the amplitude of the echo is at its maximum and the echo is rising rapidly, without too much distortion (deformations).

The following figures show the most commonly observed echo signals:

- Ideal signal: quick rise well above the detection threshold.

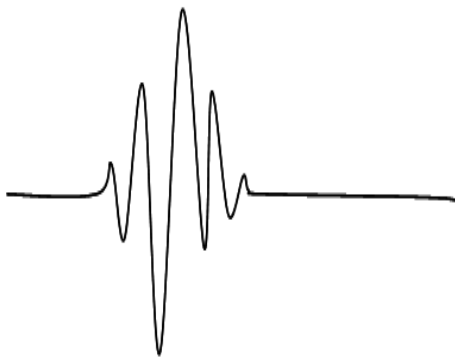

Comment: The signals observed are often longer than the one shown above. This is completely normal, the important criterion being the velocity of the signal rise above the threshold.

- Slowly rising signal:



- Signal distorted by an incorrect positioning of the probes:



- Presence of noise (acoustic interference)

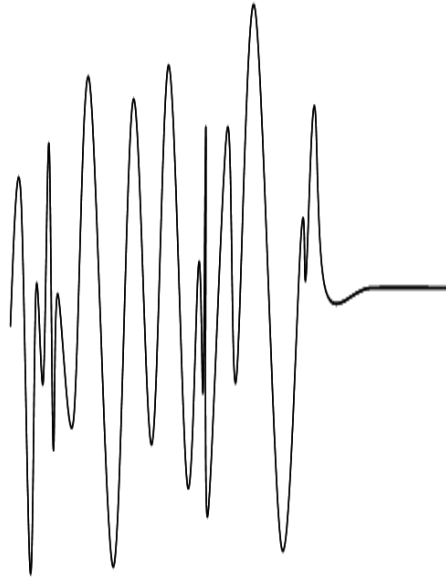

Comment: For the last three cases, a weak signal (gain greater than 50 dB) may mean that the probes require realignment or maintenance (pollution on the surface of the probe).

- Presence of electromagnetic interference



Comment: in this case, move the cables (in particular the probe cables) away from the power cables. Check the ground connections and the shielding.

Appendix II: Speed of sound in water

Sound propagation velocity in water

t (°C)	C (m/s)	t (°C)	C (m/s)
0	1422.8.	30	1506.4.
5	1426.5.	35	1520.1.
10	1447.6.	40	1529.2.
15	1466.3.	45	1536.7.
20	1482.7.	50	1542.9.
25	1497	—	—

Approximate value: $C = 1557 - 0.0245 \cdot (74 - t)^2$

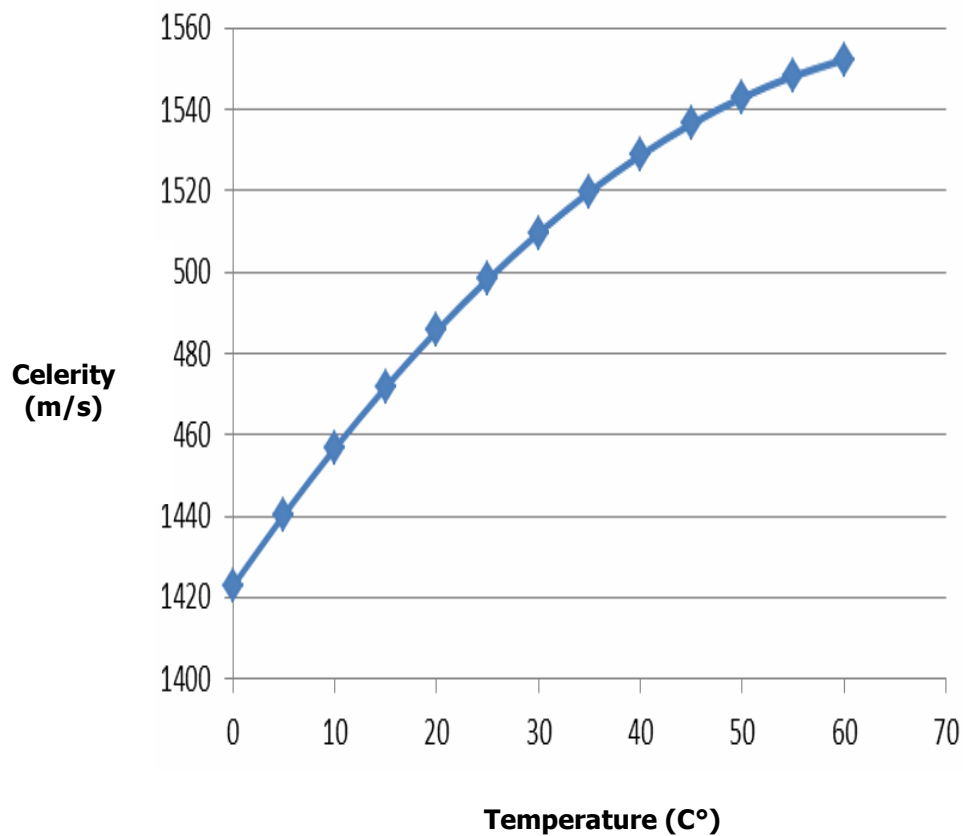

Appendix III Troubleshooting

III.1 Diagnostic indications

III.2 Description of fault bits

III.3 Fault grid

III.1 Diagnostic indications

Certain factors may lead to a degradation of the measurement. The following diagnostic indications will help you to resolve any problems which may occur.

- **The message "Velocity faults" is permanently displayed**

Possible causes:

- Probes different to those indicated in the settings. Incorrect programming of the Daxe and L settings.
- Incorrect connection of the probes. A probe may have been disconnected.
- Presence of a solid body between the probes.
- Chords out of the water.
- Probes incorrectly positioned with regard to each other.
- Probes excessively clogged.
- Fluid too absorbent, too much slurry, excessively aerated. Contact us and we will work with you to find the best solution.
- Probes defective or Uf 821 malfunctioning. Contact us if your checks result in this conclusion.

- **The message "Flow faults" appears intermittently**

The intermittent message "Flow faults" may be due to a weak echo, resulting in a high gain.

The possible causes are, to a lesser extent, identical to those of the "Velocity faults" message (see above), and in particular:

- Probes misaligned,
- Probes clogged,
- Fluid absorbent, or slurry, or aerated.

Comment: A simple way of masking intermittent measurement faults and increasing the memory storage time (see section 5.5.1).

- **The measurement differs from the predicted flow**

Actions to take

- Check that the probes are far enough away from hydraulic disturbances.
- Check the precise dimensions of the section of the pipe or the channel at the location of the measurement and the position of the probes.
- Have faith in your Uf 821.

- **The message "relay overflow" appears permanently or intermittently in the case of a relay output configured in totalizer mode**

Cause:

- Too many pulses output within the allocated time.

Actions to take

- Adapt the pulse weight and/or the width based on the flow of your application (see the "Totalizer" section 5.4.4 - point 5).

- **The message "open loop" appears permanently when setting a current output**

Cause:

- Break in the loop.

- **The message "outside limits" appears permanently or intermittently when setting an analogue input**

Cause:

- Current or voltage outside the range of use.

III.2 Description of fault bits

In general, a bit set to 1 means that there is a fault present and 0 means there is no fault. The numbering of the bits **starts at Zero!**

Two bits have the same meaning on each fault field:

BIT No.	FUNCTION NAME	DESCRIPTION
30	Fault	The measurement is faulty.
31	Not valid	Measurement is not possible, but the situation is not abnormal (1).

(1) For example, all probes are out of flow.

General fault

BIT No.	FUNCTION NAME	DESCRIPTION
4	Logger	At least one reading in the logger is not consistent.
18	Function engine	A problem has occurred on one of the outputs of the function engine. This fault is used to identify a calorimetry problem for example.
19	Ultrasound configuration	The ultrasonic board has a configuration problem.
20	Alarm C	A peripheral system has a fault.
21	Alarm B	Maintenance is required on the flow meter.
22	Alarm A	The flow meter has a general fault.
23	Access code	The maximum number of unlocking attempts has been reached. Please wait before trying again.
24	Configuration access	The configuration has been changed or the device is in echo display mode.
25	Power supply	The power supply has been cut off and restored.
26	Inputs/Outputs	Fault on an input/output module.
27	Internal clock	The clock time must be set correctly.
28	Qb	Fault on the Qb pipe.
29	Qa	Fault on the Qa pipe.
30	QT	Fault on the total flow.
31	QT not valid	Total flow invalid.

Pipe fault

BIT No.	FUNCTION NAME	DESCRIPTION
0	Velocity1	Chord 1 velocity faulty.
1	Velocity2	Chord 2 velocity faulty.
2	Velocity3	Chord 3 velocity faulty.
3	Velocity4	Chord 4 velocity faulty.
4	Velocity5	Chord 5 velocity faulty.
5	Velocity6	Chord 6 velocity faulty.
6	Velocity7	Chord 7 velocity faulty.
7	Velocity8	Chord 8 velocity faulty.
16	General velocity	All velocities are faulty.
17	General level	All levels are faulty.
18	Height velocity	The height velocity law or the automatic regression is activated.
30	Fault	Fault on a velocity.
31	Not valid	Velocity not valid.

Input/output modules fault

BIT No.	FUNCTION NAME	DESCRIPTION
0	On relay A output metering	Relay A cannot output the number of pulses required based on the programmed period.
1	Relay A output outside range	Relay A cannot output the required frequency based on the programmed range.
2	On relay B output metering	Relay B cannot output the number of pulses required based on the programmed period.
3	Relay B output outside range	Relay B cannot output the required frequency based on the programmed range.
4	Current A output loop open	Current loop open.
5	Current A output value outside range	The value of current A is outside the authorized range.
8	Value outside range input PT100/1000	The temperature measurement of PT100 A is outside the authorized range.
12	Current A input value outside range	The measurement of current A is outside the authorized range.
14	Current B input value outside range	The measurement of current B is outside the authorized range.
16	Voltage A input value outside range	The measurement of voltage A is outside the authorized range.
18	Voltage B input value outside range	The measurement of voltage B is outside the authorized range.

Chord fault

BIT No.	FUNCTION NAME	DESCRIPTION
22	Chord immersion	Chord submerged.
26	Overspeed/underspeed	Chord overspeed/underspeed.
29	Flow calculation	Chord taken into account in the flow calculation.
30	Fault	Fault on a chord.
31	Not valid	Chord not valid.

Function fault

BIT No.	FUNCTION NAME	DESCRIPTION
30	Fault	Function output fault.

III.3 Fault grid

There are three types of alarm:

- Alarm A: General fault,
- Alarm B: Maintenance requirement / Degraded mode,
- Alarm C: Alarm on peripheral system.

Using the PC software, you can find the detail of each of these alarms with the key word displayed in the fault window (see the chapter dedicated to the PC software).

The explanation of these key words is given below:

Alarm A:

KEY WORD	EXPLANATION
firmware	There is a recognition problem for the internal software of the flow meter. Contact Ultraflux.
EEprom	The non-volatile memory is faulty, measurement is impossible. Contact Ultraflux.
Function	The function engine has an execution bug. Check the inputs to the function engine. If the problem persists, contact Ultraflux.
Com .ER	There is a programming problem with the two DSP processors. Turn the flow meter off, and then back on. If the problem persists, contact Ultraflux.
Bad software	The internal software of the flow meter is not compatible with the type of flow meter programmed (Full Pipe, Open Channel, ISD, PSD, etc.). Contact Ultraflux.
Q	Fault on the flow.

Alarm B:

KEY WORD	EXPLANATION
velocity	Fault on one of the eight velocities.

Alarm C:

KEY WORD	EXPLANATION
Dataflash	The non-volatile memory is faulty; measurement is possible but not archiving by the logger. Contact Ultraflux.
logger	The logger data cannot be used or is corrupt. Contact Ultraflux.
h/w I/O	One of the inputs/outputs is no longer responding. Contact Ultraflux.
i/o	One of the inputs/outputs is incorrectly configured. Contact Ultraflux.
clock	The clock time must be set correctly.

Appendix IV: Link protocol of the Uf 821

IV.1 Serial link characteristics

IV.2 Reading of N words (with $N \leq 125$)

IV.3 Modbus/Jbus table

IV.4 CRC16 calculation algorithm

IV.1 Serial link characteristics

The characteristics of the serial link to be used are as follows:

- Protocol used: Modbus,
- Transmission speed: from 300 to 115200 bauds,
- Number of bits: 8,
- Parity: None,
- Number of stop bits: 1.

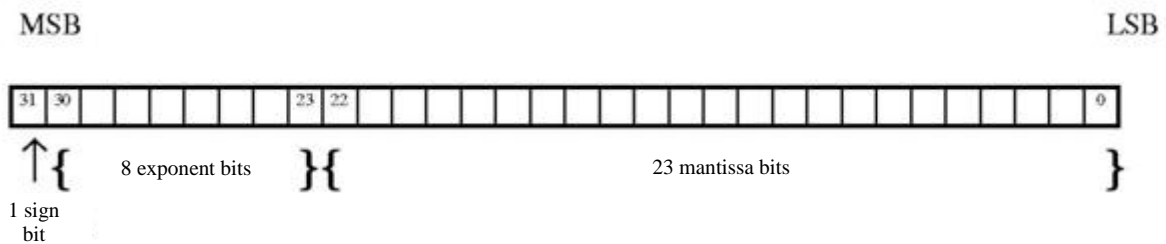

$$\text{Where: } V = (-1)^S * \left(1 + \frac{M}{2^{23}}\right) * 2^{(E-127)}$$

Example: float value = \$40, \$21, \$00, \$40

$$S = 0 ; E = , $80 = 128d ; M = 210040 = 2162752d$$

$$V = (-1)^0 * \left(1 + \frac{2162752}{2^{23}}\right) * 2^{(128-127)} = 2.5151640259$$

For FLOAT type information, it must be possible to read two consecutive words (or 4 bytes). The format complies with the IEEE standard.

For LONG type information, two consecutive words (or 4 bytes) must be read.

IV.2 Reading of N words (with $N \leq 125$)

The function code for reading N words is 3.

Request

Data	Slave no.	3	address 1st word	number of words	CRC16
Size	1 byte	1 byte	2 bytes	2 bytes	2 bytes

Response

Data	Slave no.	3	number of bytes read	value 1st word	value last word	CRC16
Size	1 byte	1 byte	1 byte	2 bytes	2 bytes	2 bytes

IV.3 Modbus / Jbus table

(1): full pipe only
(2): open channel only

For the other channel (C & D), there is simply an offset address of 200 hexadecimal or 512 decimal between each channel.

PARAMETER NAME	Type	Pipe/Channel A		Pipe/Channel B	
		JBUS Hex address	JBUS Dec address	JBUS Hex address	JBUS Dec address
Logger		0200	512	0400	1024
No. Variables Per Line	USHORT	0200	512	0400	1024
No. Completed Lines	ULONG	0201	513	0401	1025
Max. Line No.	ULONG	0203	515	0403	1027
Period (seconds)	ULONG	0205	517	0405	1029
		0207	519	0407	1031
Totalizers		0207	519	0407	1031
Totalizer1 value	ULONG	0207	519	0407	1031
Totalizer1 Weight	USHORT	0209	521	0409	1033
Totalizer1 Unit	USHORT	020A	522	040A	1034
Totalizer2 value	ULONG	020B	523	040B	1035
Totalizer2 Weight	USHORT	020D	525	040D	1037
Totalizer2 Unit	USHORT	020E	526	040E	1038
Totalizer3 value	ULONG	020F	527	040F	1039
Totalizer3 Weight	USHORT	0211	529	0411	1041
Totalizer3 Unit	USHORT	0212	530	0412	1042
Totalizer4 value	ULONG	0213	531	0413	1043
Totalizer4 Weight	USHORT	0215	533	0415	1045
Totalizer4 Unit	USHORT	0216	534	0416	1046
		0217	535	0417	1047
		0217	535	0417	1047
Year Clock	USHORT	0217	535	0417	1047
Clock Month	USHORT	0218	536	0418	1048
Clock Days	USHORT	0219	537	0419	1049
Clock Hour	USHORT	021A	538	041A	1050
Clock Minutes	USHORT	021B	539	041B	1051
Clock Seconds	USHORT	021C	540	041C	1052
QT Q	FLOAT	021D	541	041D	1053
QT unit	USHORT	021F	543	041F	1055
QT Fault	ULONG	0220	544	0420	1056
		0222	546	0422	1058
Pipe / Channel		0222	546	0422	1058
Q	FLOAT	0222	546	0422	1058
Flow unit index	USHORT	0224	548	0424	1060
Average V	FLOAT	0225	549	0425	1061
Average C	FLOAT	0227	551	0427	1063
KH (1)	FLOAT	0229	553	0429	1065
Reynolds (1)	FLOAT	022B	555	042B	1067
Surface	FLOAT	022D	557	042D	1069
Level (2)	FLOAT	022F	559	042F	1071
Height / Channel Description Point (2)	FLOAT	0231	561	0431	1073
Water Height (2)	FLOAT	0233	563	0433	1075
Water Height Max. Delta (2)	FLOAT	0235	565	0435	1077
Fault	ULONG	0237	567	0437	1079
		0239	569	0439	1081

		Pipe/Channel A		Pipe/Channel B	
PARAMETER NAME	Type	JBUS Hex address	JBUS Dec address	JBUS Hex address	JBUS Dec address
chord 01		0239	569	0439	1081
Average V	FLOAT	0239	569	0439	1081
T	FLOAT	023B	571	043B	1083
DeltaT	FLOAT	023D	573	043D	1085
C	FLOAT	023F	575	043F	1087
Gain	FLOAT	0241	577	0441	1089
IQ	FLOAT	0243	579	0443	1091
Fault	ULONG	0245	581	0445	1093
Probe Reference	USHORT	0247	583	0447	1095
Distance Between Probes	USHORT	0248	584	0448	1096
		0249	585	0449	1097
chord 02		0249	585	0449	1097
Average V	FLOAT	0249	585	0449	1097
T	FLOAT	024B	587	044B	1099
DeltaT	FLOAT	024D	589	044D	1101
C	FLOAT	024F	591	044F	1103
Gain	FLOAT	0251	593	0451	1105
IQ	FLOAT	0253	595	0453	1107
Fault	ULONG	0255	597	0455	1109
Probe Reference	USHORT	0257	599	0457	1111
Distance Between Probes	USHORT	0258	600	0458	1112
		0259	601	0459	1113
chord 03		0259	601	0459	1113
Average V	FLOAT	0259	601	0459	1113
T	FLOAT	025B	603	045B	1115
DeltaT	FLOAT	025D	605	045D	1117
C	FLOAT	025F	607	045F	1119
Gain	FLOAT	0261	609	0461	1121
IQ	FLOAT	0263	611	0463	1123
Fault	ULONG	0265	613	0465	1125
Probe Reference	USHORT	0267	615	0467	1127
Distance Between Probes	USHORT	0268	616	0468	1128
		0269	617	0469	1129
chord 04		0269	617	0469	1129
Average V	FLOAT	0269	617	0469	1129
T	FLOAT	026B	619	046B	1131
DeltaT	FLOAT	026D	621	046D	1133
C	FLOAT	026F	623	046F	1135
Gain	FLOAT	0271	625	0471	1137
IQ	FLOAT	0273	627	0473	1139
Fault	ULONG	0275	629	0475	1141
Probe Reference	USHORT	0277	631	0477	1143
Distance Between Probes	USHORT	0278	632	0478	1144
		0279	633	0479	1145

		Pipe/Channel A		Pipe/Channel B	
PARAMETER NAME	Type	JBUS Hex address	JBUS Dec address	JBUS Hex address	JBUS Dec address
Inputs/Outputs		02C9	713	04C9	1225
IO 01A		02C9	713	04C9	1225
Value	FLOAT	02C9	713	04C9	1225
Fault	ULONG	02CB	715	04CB	1227
		02CD	717	04CD	1229
IO 01B		02CD	717	04CD	1229
Value	FLOAT	02CD	717	04CD	1229
Fault	ULONG	02CF	719	04CF	1231
		02D1	721	04D1	1233
IO 02A		02D1	721	04D1	1233
Value	FLOAT	02D1	721	04D1	1233
Fault	ULONG	02D3	723	04D3	1235
		02D5	725	04D5	1237
IO 02B		02D5	725	04D5	1237
Value	FLOAT	02D5	725	04D5	1237
Fault	ULONG	02D7	727	04D7	1239
		02D9	729	04D9	1241
IO 03A		02D9	729	04D9	1241
Value	FLOAT	02D9	729	04D9	1241
Fault	ULONG	02DB	731	04DB	1243
		02DD	733	04DD	1245
IO 03B		02DD	733	04DD	1245
Value	FLOAT	02DD	733	04DD	1245
Fault	ULONG	02DF	735	04DF	1247
		02E1	737	04E1	1249
IO 04A		02E1	737	04E1	1249
Value	FLOAT	02E1	737	04E1	1249
Fault	ULONG	02E3	739	04E3	1251
		02E5	741	04E5	1253
IO 04B		02E5	741	04E5	1253
Value	FLOAT	02E5	741	04E5	1253
Fault	ULONG	02E7	743	04E7	1255
		02E9	745	04E9	1257

		Pipe/Channel A		Pipe/Channel B	
PARAMETER NAME	Type	JBUS Hex address	JBUS Dec address	JBUS Hex address	JBUS Dec address
Function output Start		0319	793	0519	1305
Function output 01		0319	793	0519	1305
Value	FLOAT	0319	793	0519	1305
Fault	ULONG	031B	795	051B	1307
		031D	797	051D	1309
Function output 02		031D	797	051D	1309
Value	FLOAT	031D	797	051D	1309
Fault	ULONG	031F	799	051F	1311
		0321	801	0521	1313
Function output 03		0321	801	0521	1313
Value	FLOAT	0321	801	0521	1313
Fault	ULONG	0323	803	0523	1315
		0325	805	0525	1317
Function output 04		0325	805	0525	1317
Value	FLOAT	0325	805	0525	1317
Fault	ULONG	0327	807	0527	1319
		0329	809	0529	1321
Function output 05		0329	809	0529	1321
Value	FLOAT	0329	809	0529	1321
Fault	ULONG	032B	811	052B	1323
		032D	813	052D	1325
Function output 06		032D	813	052D	1325
Value	FLOAT	032D	813	052D	1325
Fault	ULONG	032F	815	052F	1327
		0331	817	0531	1329
Function output 07		0331	817	0531	1329
Value	FLOAT	0331	817	0531	1329
Fault	ULONG	0333	819	0533	1331
		0335	821	0535	1333
Function output 08		0335	821	0535	1333
Value	FLOAT	0335	821	0535	1333
Fault	ULONG	0337	823	0537	1335
		0339	825	0539	1337
Function output 09		0339	825	0539	1337
Value	FLOAT	0339	825	0539	1337
Fault	ULONG	033B	827	053B	1339
		033D	829	053D	1341
Function output 10		033D	829	053D	1341
Value	FLOAT	033D	829	053D	1341
Fault	ULONG	033F	831	053F	1343

IV.4 CRC16 calculation algorithm

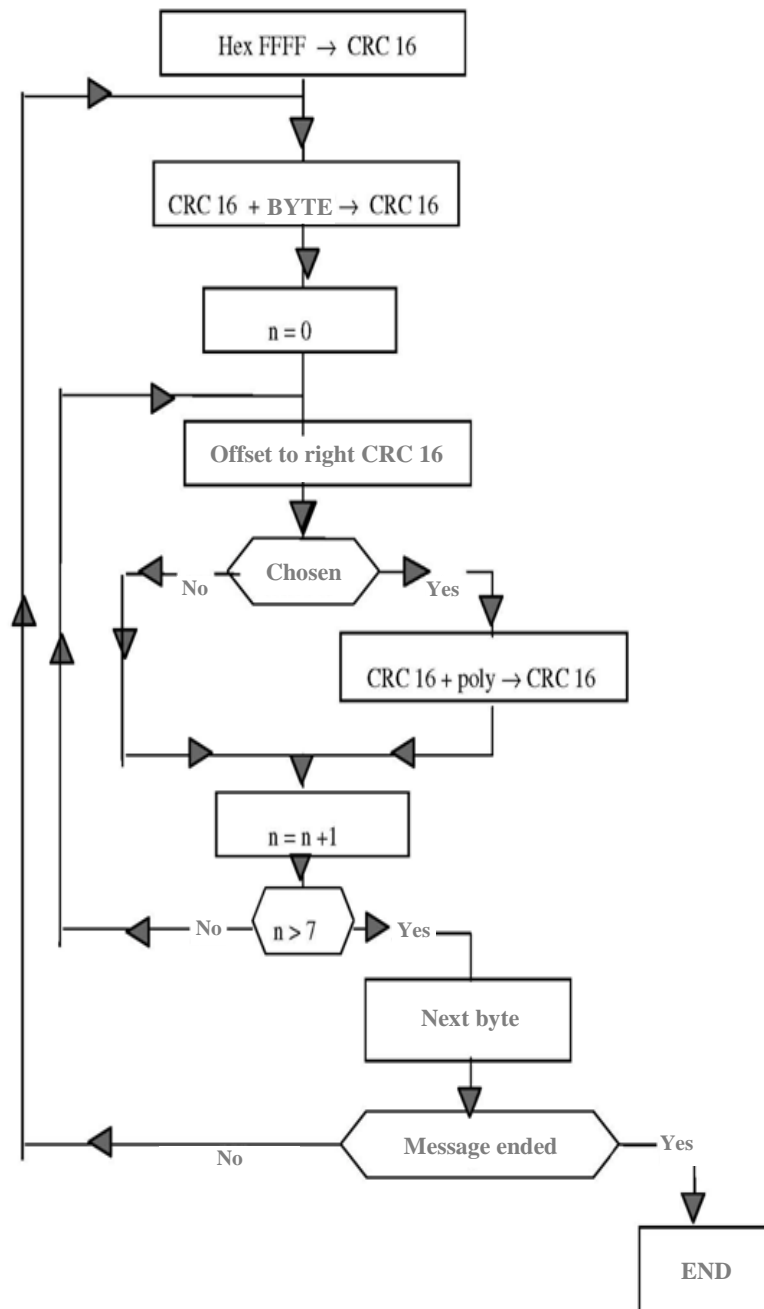

\oplus = exclusive OR

n = number of bits

poly = calculation polynomial of CRC16 = 1010 0000 0000 0001 (generator polynomial = $2 X^2 X^{15} X^{16}$)

the first byte sent is the one with the least significant bits

DETAILED TABLE OF CONTENTS

CHAPTER 1: OVERVIEW	4
1.1 General view of the converter	5
1.1.1 Unit closed	5
1.1.2 Unit open	6
1.2 Nature of the equipment	7
1.3 Dimensions and weight	7
1.4 Operating environment	7
1.5 Physical protection	7
1.6 Power supply	8
1.7 Communication	8
1.8 Inputs/Outputs	9
1.9 Ultrasound chords	9
1.10 Navigation keys	9
1.11 Operating lights	10
1.12 Screen	10
1.13 Functions	11
1.14 Performance of the flow meter	11
1.15 Cleaning the flow meter	11
1.16 Recycling the flow meter	12
1.17 CE marking	12
CHAPTER 2: SAFETY INSTRUCTIONS	13
2.1 Using the flow meter	14
2.2 Equipment connected to the flow meter	15
2.3 Symbols used on the flow meter	15
2.4 Maintenance work on the flow meter	16
2.5 Contact address	17
CHAPTER 3: INSTALLATION AND WIRING	18
3.1 General	19
3.2 Wall mounting and space requirement	19
3.3 Using the cabinet	20
3.4 Using the lid stay	21
3.5 Tool-free removal of the lid	21
3.6 Wiring instructions	22
3.7 Connection to the protective ground (to be carried out first)	22
3.8 Wiring the Terminals	22
3.8.1 Power supply	22
3.8.2 Ultrasonic chords	23

3.8.3 Input/output terminals	24
1) Wiring of the current output modules	25
2) Wiring of the current input modules	25
3) Wiring of the voltage input modules	25
4) Wiring of the relay modules	25
5) Wiring of the temperature modules	26
3.8.4 Communication terminal board	26
3.9 USB Connection	27
CHAPTER 4: IMPLEMENTING A MEASURING POINT	28
4.1 Choosing the measurement location	29
4.2 Installing the probes	29
4.3 Measurements to be taken on site	30
4.3.1 Topography of the site	30
4.3.2 Determining the different levels in relation to the stream	30
4.4 Analysing and processing data measured on site	30
4.5 Transferring the data collected to the converter	31
CHAPTER 5: USING AND CONFIGURING THE Uf 821	32
5.1 Using the Uf 821	33
5.1.1 Operating mode	33
5.1.2 Keypad	34
5.1.3 LEDs	35
5.2 Main configuration elements	36
5.2.1 Geometric and physical definition of the measuring point	36
1) Composition of a measuring point	36
2) Reference systems used	36
3) Definition of the reference planes	36
4) Correspondence between customer reference system and section description reference system	38
5.2.2 Number of channels	38
5.3 Configuring the Uf 821	39
5.3.1 Flow meter menu	39
5.4 SIMPLE configuration mode	40
5.4.1 "Configuration" menu	40
1) "Option Files" window	40
2) Reset	40
3) Confirmation (of reset)	40
4) Settings	41
5) Menu	41
6) Access code	41
7) Language	41
8) Station name	41
9) Back light	42
10) Connection	42
11) Time delay before return to "Measurement" mode	42
5.4.2 "Pipe/fluid settings" menu	43
1) Number of chords	43
2) Flow unit (unit Q)	43
3) Flow graph	43
4) Type of fluid	43
5) Chord settings	43
5.4.3 "Section Description" menu	44

1) Section description	44
2) Gauge offset	44
3) Surface S0	44
5.4.4 "Level settings" menu	45
1) Number of level measurements	45
5.4.5 "Hydraulic Profile" menu	45
1) Description of the hydraulic profile	45
2) Choosing the definition mode of the hydraulic profile	47
3) Absolute mode	47
4) Relative mode	48
5.4.6 "Height/velocity settings" menu	48
1) Velocity profile in low water situation	48
5.4.7 "Totalizer settings" menu (if activated)	50
1) Activation and direction of metering	50
2) Pulse unit and weight	50
3) Resetting a totalizer (if authorised)	50
5.4.8 "Input/Output settings" menu (if activated)	51
1) Current input and voltage input module	51
2) Temperature input module	52
3) Contact input module	52
4) Current/voltage output module	52
5) Relay output module	53
5.4.9 "Logger settings" menu (if activated)	55
1) Resetting the logger	55
2) Confirming logger reset	55
3) Number of logger parameters	55
4) Logger mode	55
5) Logger increments	55
6) Logger autonomy	55
7) Logger variables	56
8) Logger on variation	56
5.4.10 "Echo Display" menu	57
5.5 NORMAL configuration mode	58
5.5.1 "Pipe/fluid settings" menu	58
1) Memory	58
2) Filter	59
3) Deletion rate (CutOff Q)	60
4) Product	60
5) Delta T0	60
6) Vmin and Vmax	60
7) Probe immersion depth	60
5.6 ADVANCED configuration	61
5.6.1 "Pipe/fluid settings" menu	61
1) Delta V filtering	61
2) Weighting coefficients of the chords	61
3) Required gain and Maximum gain	61
5.6.2 "Linearization settings" menu	62
5.6.3 "Advanced configuration" menu	62
1) Simulation mode	62
2) Special probes	63
3) US & TRT processing	63
5.6.4 "Firmware update" menu	63
5.7 "Measurement" mode	64
5.7.1 Available pages	64
1) Flow rate	64
2) Channel measurement	64

3) Specific information relating to the chords	64
4) Totalizers	65
5) Date and time	65
6) Logger info	65
7) Events	65
8) Probe type	66
9) Flow graph	66
5.7.2 Verification of measurement quality and consistency	66

CHAPTER 6: FUNCTION ENGINE **67**

6.1 Principle	68
6.2 Application example	68
6.2.1 Water temperature calculation	68

CHAPTER 7: PC SOFTWARE **69**

7.1 Introduction	70
7.1.1 Installing and running the software	70
7.1.2 Connecting the flow meter to the PC	71
7.1.3 Home page	71
7.1.4 Options window	72
7.1.5 Icons	72
7.1.6 File menu	73
7.1.7 Measurement window	73
1) List of available tabs	73
2) "General" tab	74
3) "QA" tab (flow rate)	75
4) "Input-output" tab	76
7.1.8 Settings window	76
1) List of available tabs	76
2) "General" tab (in the "General" drop-down menu)	77
3) "Logger" tab (in the "General" drop-down menu)	78
4) "Totalizers" tab (in the "General" drop-down menu)	78
5) "Inputs/Outputs" tab (in the "General" drop-down menu)	79
6) "Channel" tab (in the "Channel" drop-down menu)	80
7) "Chord" tab (in the "Channel" drop-down menu)	80
8) "Section" tab (in the "Channel" drop-down menu)	81
9) "Hydraulic Profile" tab (in the "Channel" drop-down menu)	82
10) "Level" tab (in the "Channel" drop-down menu)	82
11) "Height/Velocity" tab (in the "Channel" drop-down menu)	83
12) "Linearisation" tab (in the "Channel" drop-down menu)	83
7.2 Archiving, processing and printing of saved files	84
7.3 Settings files	84

Appendix I: Characteristic echo signals	85
Appendix II: Speed of sound in water	88
Appendix III Troubleshooting	90
III.1 Diagnostic indications	91
III.2 Description of fault bits	93
III.3 Fault grid	96
Appendix IV: Link protocol of the Uf 821	97
IV.1 Serial link characteristics	98
IV.2 Reading of N words (with $N \leq 125$)	99
IV.3 Modbus / Jbus table	100
IV.4 CRC16 calculation algorithm	104